



WORLDWIDE GENERAL CATALOGUE



CAESAR
GUERINI



CAESAR GUERINI

Ancient Quality Latest Technology

Caesar Guerini: sapore di conquista

L'arte venatoria è certamente l'attività più antica sviluppata dall'uomo; i suoi attrezzi, si sono evoluti insieme alle sue necessità affinandosi ed evolvendosi fino a raggiungere le caratteristiche tecniche ed estetiche degli odierni fucili unendo l'efficacia d'azione con l'estetica del prodotto.

Il mercato propone attualmente armi di ogni tipo e fattezza, che pur non mostrando caratteristiche estetiche eccezionali, sono certamente efficaci.

Efficaci sì, ma non apprezzate da chi della disciplina venatoria fa un'arte e non un mero abbattimento di selvatici.

La Caesar Guerini si propone come una ditta che unisce queste particolari peculiarità: la bellezza estetica e la validità intrinseca del prodotto.

Un connubio perfetto fra cacciatore e preda. Le molteplici proposte della Caesar Guerini si rivolgono ad un pubblico raffinato ed esigente, che predilige armi estremamente curate nei particolari, dalla meccanica impeccabile, eccellenti doti balistiche e dal brandeggio facile e sicuro. Pregi finemente ricercati con maniacale attenzione, in relazione alla specialità alla quale sono destinati.

Utilizzare quindi fucili Caesar Guerini, appaga il desiderio di disporre di un'arma adatta ad ogni situazione, venatoria o sportiva, verso il sicuro raggiungimento del top delle performance ricercato dagli appassionati.

Caesar Guerini: an Unrelenting Conquest for Excellence

Hunting is among the oldest of all men's activities.

Its "tools" along with its purposes have evolved and have been refined over time becoming modern firearms that combine technical and aesthetic features with performance and beauty.

Today, the market offers firearms of all types but most, despite being effective, are neither aesthetically pleasing nor distinctive. However efficiency is no longer enough for those outdoorsmen who consider hunting as an art form and not just the harvesting of game.

These discriminating hunters also see their firearms as an extension of that art form. Caesar Guerini has always strived to combine outstanding reliability and performance with classic elegance in its firearms, becoming the perfect link between hunters and prey. Caesar Guerini's wide range of products has been created for a refined and demanding public who want firearms with impeccable mechanisms, excellent ballistic performance, easy and safe handling features and exacting attention to detail. Prestigious shotguns whose features have been studied with almost maniacal precision and have been gauged to their use.

Shooting a Caesar Guerini shotgun means using a gun suitable for all hunting or competition situations and one which always performs to the highest expectations of the most demanding hunter or target shooter.



Christophe Auvret



Lyndon Sosa



Richard Faulds



Kirsty Barr

CAESAR GUERINI

- 2018 • **GOLD**, WORLD FITASC SPORTING CHAMPIONSHIP, Saint Lambert, France, Christophe Auvret
- 2018 • **GOLD**, ISSF TRAP WORLD CHAMPIONSHIP, Guadalajara, Mexico, Lyndon Sosa
- 2018 • **GOLD**, BRITISH OPEN SPORTING, STAFFORDSHIRE, United Kingdom, Richard Faulds
- 2018 • **GOLD**, FITASC SPORTING HUNGARIAN GP, Junior cat., Valo David
- 2018 • **SILVER**, EUROPEAN SHOOTING CHAMPIONSHIP, OLYMPIC TRAP, Leobersdorf, Austria, Kirsty Barr
- 2018 • **BRONZE**, FITASC SPORTING BRITISH GP, John Lee
- 2017 • **GOLD**, SPORTING EUROPEAN CHAMPIONSHIP, FINAL OF EUROPEAN SPORTING CUP, Dorset, United Kingdom, Christophe Auvret
- 2017 • **GOLD**, ICTSF ENGLISH SPORTING CHAMPIONSHIP, Kelmarsh, United Kingdom, Richard Faulds
- 2017 • **GOLD**, ENGLISH OPEN ABT CHAMPIONSHIP, Mark Shaw
- 2017 • **GOLD**, UNIVERSAL TRENCH EUROPE CHAMPIONSHIP, Junior Cat., Paccou Yannick
- 2017 • **SILVER**, COMPAK SPORTING EUROPEAN CHAMPIONSHIP, FINAL OF EUROPEAN CUP, Bydgoszcz, Poland, Christophe Auvret

- 2017 • **SILVER**, ENGLISH OPEN OLYMPIC TRAP CHAMPIONSHIP, Kirsty Barr
- 2017 • **SILVER**, ENGLISH OPEN OLYMPIC TRAP CHAMPIONSHIP, Mark Shaw
- 2017 • **SILVER**, SPORTING EUROPEAN CHAMPIONSHIP, FINAL OF EUROPEAN SPORTING CUP, Dorset, United Kingdom, Janine Preece
- 2017 • **BRONZE**, UNIVERSAL TRENCH WORLD CHAMPIONSHIP, FINALE OF WORLD CUP, France, Stéphanie Neau
- 2016 • **GOLD**, TRAP MEN WORLD CHAMPIONSHIP OF UNIVERSITY, Bydgoszcz, Poland, Lyndon Sosa
- 2016 • **GOLD**, UNIVERSAL TRENCH EUROPEAN CHAMPIONSHIP, Hungary, Stéphanie Neau
- 2016 • **SILVER**, WORLD FITASC COMPAK SPORTING CLAY SHOOTING CHAMPIONSHIP, Buckinghamshire, England, Christophe Auvret
- 2016 • **SILVER**, WORLD FITASC COMPAK SPORTING CLAY SHOOTING CHAMPIONSHIP, Veteran Cat., Buckinghamshire, England, Martin Doughty
- 2016 • **BRONZE**, UNIVERSAL TRENCH EUROPEAN CHAMPIONSHIP, France, Fabien Couvidat
- 2016 • **BRONZE**, UNIVERSAL TRENCH EUROPEAN CHAMPIONSHIP, France, Audrey Germain

- 2015 • **SILVER**, WORLD FITASC COMPAK SPORTING CHAMPIONSHIP, Estonie, Christophe Auvret
- 2015 • **BRONZE**, EUROPEAN CHAMPIONSHIP, FINAL OF EUROPEAN CUP, HUNGARY, Christophe Auvret
- 2014 • **GOLD**, COMPAK SPORTING EUROPEAN CHAMPIONSHIP, Signes, France, Christophe Auvret
- 2014 • **GOLD**, US OPEN SPORTING CLAYS, U.S.A., Richard Faulds
- 2014 • **GOLD**, BRITISH OPEN SPORTING CLAYS, Brett Winstanley
- 2013 • **GOLD**, WORLD ENGLISH SPORTING CHAMPIONSHIP, San Antonio, Texas, Richard Faulds
- 2013 • **GOLD**, ISSF WORLD CUP, Acapulco, Mexico, Amber Hill
- 2013 • **SILVER**, EUROPEAN COMPAK SPORTING CHAMPIONSHIP, Rio Salso, Italy, Richard Faulds
- 2013 • **SILVER**, WORLD ICTSF CLAY SHOOTING CHAMPIONSHIP, Ontario, Canada, Richard Faulds
- 2012 • **SILVER**, WORLD CHAMPIONSHIP, FINALE OF SPORTING WORLD CUP, Veteran cat., U.S.A., John Wolley



RICONOSCIMENTI ACKNOWLEDGEMENTS

CAESAR GUERINI



2003
MAGNUS LIGHT GROUSE
"Best Gun of the Year"
Outdoor Life Magazine



2003
TEMPIO
"Best of the Best"
Field & Stream Magazine



2005
CAESAR GUERINI
"Excellence"
Sporting Classics Magazine



2007
MAXUM TRAP AT
"Editor's Choice"
Outdoor Life Magazine



2008
SUMMIT DUAL SPORTING
"Best of the Best"
Field & Stream Magazine



2009
APEX SPORTING
"Editor's Choice"
Outdoor Life Magazine



2010
SUMMIT BLACK IMPACT
"Editor's Choice"
Outdoor Life Magazine



2010
ELLIPSE EVO
"Best of the Best"
Field & Stream Magazine



2011
ELLIPSE EVO LIGHT
"Editor's Choice"
Outdoor Life Magazine



2011
ELLIPSE EVO
"Trophées Connaissance
de la Chasse"
Connaissance de la Chasse



2013
CAESAR GUERINI
"Excellence"
Sporting Classics Magazine



2014
CAESAR GUERINI
"Company of the Year"
"Excellence"
Sporting Classics Magazine

Caratteristiche tecniche dei fucili sovrapposti
Over and Under shotgun technical features



Le bascule, sia quelle in acciaio, sia in lega leggera, sono ricavate da un massello forgiato, il che significa che le fibre del materiale non subiscono alcun taglio d'utensile, a tutto vantaggio della resistenza del materiale stesso per l'assorbimento dell'esplosione dei colpi. Tutte le bascule al NiCrMo subiscono un procedimento di cementazione e tempera che garantisce una flessibilità ottimale al cuore del prodotto lasciando la superficie molto dura.



Since our actions are forged from solid billets, in either steel or light alloy, the material does not experience excessive cutting during machining. Therefore the actions are stronger and absorb recoil better. All our actions in NiCrMo are cemented and hardened to have a very flexible core and a very hard surface.



1320 BAR

Infatti tutti i modelli Caesar Guerini, compresi i superleggeri, vengono sottoposti al test impiegando la pressione massima di 1320 Bar presso il Banco Nazionale di Prova Italiano.

Inoltre i perni cerniera riportati, in materiale ad alta resistenza, sono intercambiabili ed i ramponi con grande superficie di chiusura contribuiscono alla resistenza e alla durata dell'arma nel tempo. Nei modelli che prevedono cartelle laterali, queste non presentano alcuna vite di bloccaggio sul legno, ma vengono fissate ad incastro e perfettamente adattate al legno della calciatura. Questo da un lato consente un'incisione omogenea senza dover tenere conto delle

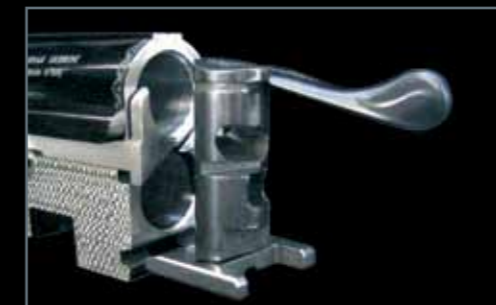

teste delle viti, mentre dall'altro evidenzia una eccellente preparazione meccanica che consente un assemblaggio praticamente privo di tolleranze.

All Caesar Guerini shotguns, including the extra light models, undergo the 1320-bar high-pressure test at the Italian National Proof House. The hinge pins are made from an extremely wear/stress resistant material and are fully interchangeable. The locking lugs, with their wide working surface, contribute to the resistance and longevity of the shotguns. Our side-plated models feature completely pin less side plates that feature a stunningly seamless engraving canvas. This unique feature bears evidence of how precisely, and with extremely close tolerances, our shotguns are built and assembled.

In quasi tutti i modelli della Caesar Guerini la tiratura della testa di bascula viene eseguita manualmente. Questa è una caratteristica presente in genere nei fucili fini e che raramente si riscontra in prodotti industriali. Almost all Caesar Guerini shotguns feature hand-filed fences that are typical of very high-quality hand-made shotguns but are rarely seen on mass produced products.



I fucili presentano incisioni molto raffinate eseguite con procedimenti diversi e sempre rifinite manualmente dai migliori Maestri incisori con risultati estremamente accattivanti e degni della classe del fucile a cui appartengono. Caesar Guerini shotguns feature very refined engraving patterns executed using different techniques but are always hand finished by the best master engravers. The results are extremely beautiful and contribute to the overall quality of the guns.



La croce è provvista di un inserto intercambiabile, in acciaio speciale, posto sul punto d'appoggio tra il tenone della canna e la croce stessa che consente di ripristinare facilmente eventuali lussure (tiraggio) dovute all'elevato uso dell'arma. The iron fore-end always comes with an interchangeable insert in special steel that makes it easy to tighten the shotgun if it becomes loose through years of very heavy use.



Il gruppo di sparo è concepito in modo da avere scatti sicuri e veloci. Il monogrillo, dorato in alcuni modelli da caccia, è del tipo inerziale con bilanciare sdoppiato. Il collegamento tra il bilanciare e la massa, (fissata sulla bascula anziché sul grilletto, a garanzia di sicurezza contro cadute accidentali o colpi) è realizzato con una sfera mobile per ridurre al minimo gli attriti durante la fase di sparo. The triggers are fast, safe and crisp. The inertia single trigger, gold-plated on some hunting models, is provided with a double compensator: the link between compensator and inertia block (situated on the action and not on the trigger to enhance safety in case of accidental drops or hits) features a mobile ball which reduces friction to the minimum while shooting.

Nei modelli atti alle discipline sportive, viene fornito un grilletto regolabile in modo micrometrico, così da permettere anche le più piccole variazioni, al fine di ottimizzare non solo la lunghezza del calcio, ma anche l'impugnatura, così da personalizzare al meglio il proprio fucile da tiro. Competition shotguns come with adjustable triggers which allow even micrometric adjustments to optimize not only the length of the trigger pull but also the grip, turning the shotgun in a true personalized shooting tool.

I cani, con le loro leve, presentano una seconda monta che interviene nel caso di un eventuale danneggiamento della prima, a tutto vantaggio della sicurezza; sono azionati da molle a spirale precaricate e costanti e sono previsti con rimbalzo, così come sui fucili di prestigio. Questa configurazione fa sì che il percussore non sporga mai, dopo lo sparo, dal piano di culatta, a garanzia di sicurezza e per garantire una dolcezza di apertura delle canne dopo lo sparo.

Nelle bascule in lega leggera sono stati inseriti nella culatta due inserti intercambiabili in acciaio inox al fine di garantire la massima durata dell'arma sia contro l'usura che contro la corrosione generata dai gas di scarico delle munizioni. Sul bottone di sicura, alloggiato sulla coda della bascula, è montato il selettore che rende l'operazione di selezione facile e immediata. The two-stage hammers also enhance safety. They are operated by pre-charged coil springs and are of the rebounding type, which is typical of prestigious and more costly shotguns. As a consequence the firing pins never protrude from the face after the shotgun has been fired which, once again, makes the shotgun safer and very smooth to open. Receivers in light alloy come with two interchangeable stainless steel inserts in the breech. They make the guns extremely resistant to wear and corrosion generated by cartridge discharge gases. The tang safety comes with a selector that is easy to use and responsive to the touch.



Gli estrattori automatici presentano una camma di azionamento a grande sviluppo ricavata dal pieno direttamente sull'estrattore. Ciò determina una resistenza tale da garantire una sicura e costante forza di estrazione anche usando munizioni con cariche molto forti. Il fermo degli estrattori è garantito da una pastiglia che, essendo per sua natura priva di spigoli, evita rotture degli estrattori stessi anche a fronte di un uso esasperato. Questo sistema è oggi presente solo su fucili di altissima qualità.

Le canne, ricavate da materiale in acciaio al cromo molibdeno, sono forate ed alesate e con la particolare geometria interna garantiscono massima elasticità a tutto vantaggio delle performance balistiche. Inoltre presentano esteticamente un fondo qualitativamente impeccabile grazie ad una doppia pulitura dapprima manuale e successivamente robotizzata. A disposizione del cliente, varie tipologie di mirini e bindelle superiori, diversificate in relazione alla destinazione finale d'utilizzo. Per i modelli da caccia, vi sono bindelle superiori ventilate coniche, mentre nei modelli più prestigiosi si impiegano bindelle senza ventilazioni coniche di tipo classico; entrambe completamente arabescate, sulle quali vengono montati mirini sferici in ottone. Sui modelli di destinazione sportiva, vengono montati mirini bianchi sferici su bindelle da 10 mm ventilate coniche; queste vengono arabescate in modo da creare una linea ribassata longitudinale per tutta la loro lunghezza, in modo da favorire il tiratore nel controllo della propria posizione di tiro.

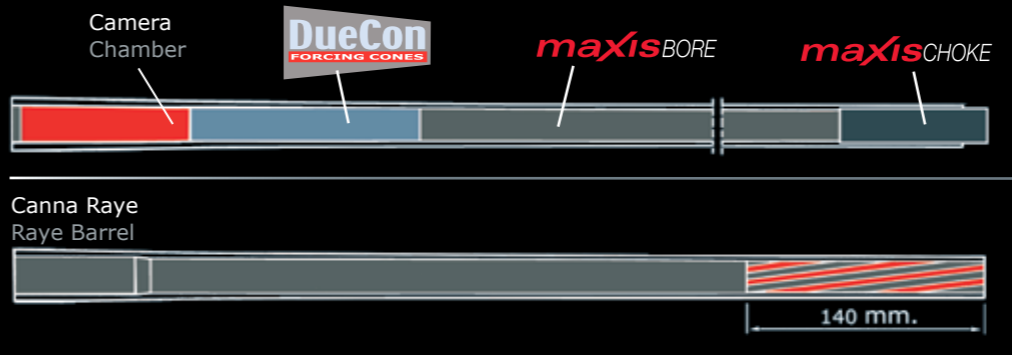

The ejectors feature a solid operating cam making the extraction safe and reliable with all types of ammunition, even shells with the heaviest loads. The ejector stop is secured by a round boss that, not having any corners, prevents the ejectors from breaking even when the shotgun is used very heavily. This is typical only of very fine guns. The barrels in Chrome-Moly steel are drilled and reamed to improve elasticity and, therefore, ballistic performance. They also come with an impeccable finish thanks to a double polishing process: by hand first and then by robot. We offer different types of top ribs and sights depending on the use the shotgun is intended for. Our standard field shotguns come with ventilated top ribs while our high quality field models come with traditional solid tapered ribs. Both ribs are filed and provided with brass beads. Our competition shotguns come with white beads mounted on 10-mm tapered top ribs. The longitudinal filing of the ribs allows shooters to better control their aiming positions.

A richiesta del cliente finale, le canne vengono fornite con specifica "Steel Shot", per permettere all'arma di esplodere cartucce con pallini d'acciaio. Nelle canne calibro 12 è stata studiata una nuova geometria dell'anima denominata "Maxisbore". Contemporaneamente alla nuova anima è stato messo a punto un nuovo cono di raccordo tra camera e anima denominato "Duecon". I progetti "Maxisbore" e "DueCon" permettono entrambi ai pallini delle cartucce sparate di assumere una velocità superiore, una minore deformazione e garantiscono una notevole riduzione del rinculo. Nei modelli in lega leggera sono disponibili, a richiesta, canne speciali "RAYE" studiate appositamente per i tiri ravvicinati tipici della caccia alla beccaccia nel bosco. La canna presenta un tubo superiore provvisto di strozzatore intercambiabile "Maxischoke", mentre negli ultimi 14 cm del tubo inferiore troviamo una raggiatura elicoidale che conferisce alla rosata una distribuzione di pallini ampia ed omogenea fin dai primi 8-10 metri.

Unitamente al progetto "Maxisbore", sono nati gli strozzatori "Maxischoke", più lunghi dei modelli "Selectachoke", conferiscono un angolo più dolce nella strozzatura a tutto vantaggio della qualità della rosata stessa. Tutti gli strozzatori della Caesar Guerini ("Selectachoke" o "Maxischoke") sia per la caccia che per il tiro, sono costruiti in acciaio legato ad alta resistenza e sono disponibili con diverse misure di strozzatura.



maxisCHOKE



maxisCHOKE COMPETITION

On request our barrels can undergo the "Steel Shot" test. Our 12ga barrels feature a new bore geometry called "Maxisbore". The new bore has also been combined with a new forcing cone between chambers and bore called "Duecon". Both "Maxisbore" and "DueCon" make it possible to increase pellet velocity, reduce misshaping and decrease felt recoil. On request our shotguns in light alloy can be provided with our special "RAYE" barrels specifically studied for woodcock hunting in the woods. The top tube comes with an interchangeable "Maxischoke" choke tube while the last 14 cm of the lower tube feature a special radius, which generates a very wide, even and homogenous shot pattern even at 8-10 meters. Along with the "Maxisbore" project we have also introduced our "Maxischoke" interchangeable choke tubes. They are longer than the "Selectachoke" models. Their constriction angle is smoother to the advantage of the shot pattern. Every choke tube in the Caesar Guerini line

("Selectachokes" and "Maxichokes") is made of special steel alloy and is extremely resistant. Different constrictions are available for our field and competition shotguns.

Elevata è la qualità dei legni, cui si unisce una finitura a olio sempre riparabile dall'utilizzatore finale e zigri rifiniti manualmente a passo molto fine, caratteristiche solitamente presenti nei soli fucili di alta qualità. Stocks in extra select wood feature an oil finish which is very easy to repair and exactly cut hand-finished checkering, which is typical only of finer guns.



I modelli ideati per la caccia, presentano una calciatura molto elegante dotata di una pistola arrotondata tipo "Principe di Galles". Questa pistola, realizzata a mano, si differenzia dalle comuni pistole tonde eseguite a macchina, in quanto conferisce una forte caratterizzazione al fucile. Dal punto di vista pratico, essendo priva di spigoli, permette una presa confortevole e pronta anche a mani di diverse dimensioni. Nelle calciature con la pistola "Principe di Galles" viene montato un elegante calciolo in legno zigriato. Our hunting shotguns come with very elegant "Prince of Wales" stocks. The hand-made round pistol grip is different from standard machine-cut grips, giving these shotguns a distinctive personality. Devoid of any sharp corners, these special pistol grips make the guns easy to handle for people with different-sized hands. Elegantly checkered butt plates complete our "Prince of Wales" stocks.



Diversa è la scelta dei legni per le discipline sportive, che oltre a possedere una massa superiore, montano calcio a pistola con calcioli in gomma tirati a filo.

Il calcio, a differenza dei legni da caccia, monta uno speciale dispositivo, che abbinato alla chiave in dotazione, permette un facile smontaggio del legno.

La fascia alta dei prodotti, sia nei modelli da caccia che da tiro, è contrassegnata oltre che da meravigliose incisioni manuali, anche dalla presenza di guardie lunghe incassate perfettamente e saldamente nella pistola senza l'ausilio di alcuna vite, fino a raggiungere una elegante cocchia metallica che dona un perfetto tocco di stile.

Our competition shotguns come with pistol grip stocks developed specifically for the needs of target shooters and are finished off with rubber pads. These stocks are provided with an internal captive locking bolt and a T-wrench that makes the stocks easily removable.

Our top of the line hunting and sporting shotguns are finely hand engraved and feature long tang trigger guards firmly inlet into the pistol grip without the use of any screw.



The long trigger guard extends all the way to a perfectly shaped metal cap.

Ai calci vengono scelte ed accoppiate aste dal legno rigorosamente selezionato: per i fucili da caccia, sono disponibili eleganti aste tonde o a "becco d'oca".

Di queste ultime, sono dotati anche i modelli sporting; ai modelli trap, vengono invece abbinaste aste del tipo "coda di castoro".

Le astine montano nella parte superiore un pulsante di sgancio decisamente facile da usare, che conferisce un aspetto estetico ben più gradevole rispetto al classico auget.

Anche questo è un particolare raramente presente sui fucili di produzione industriale.

Our shotguns all feature perfectly matching forends. The hunting models come with either elegant round forends or Schnabel forends.

The sporting models feature Schnabel forends while the Trap models come with beavertail forends.

All forends are provided with Anson-style release buttons, which are easy to use and aesthetically more attractive than the traditional latch levers: another feature that is more typical of custom or limited production guns.

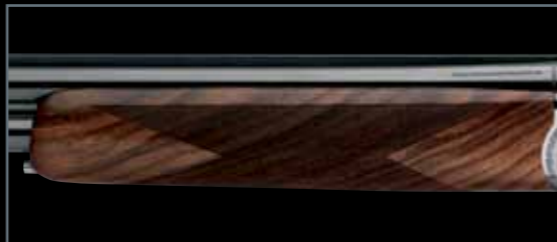

PROGETTO "DTS" "DTS" PROJECT

Il progetto "DTS", acronimo di "Dynamic Tuning System", è nato alcuni anni fa grazie all'impegno profuso dai nostri tecnici ed ai cospicui investimenti aziendali, stanziati per la ricerca e lo sviluppo.

L'obiettivo del progetto "DTS", è di fornire soluzioni tecnologiche all'avanguardia, volte a soddisfare le sempre maggiori richieste di customizzazione dei prodotti da parte degli utenti finali.

Quindi, tecnologia ed innovazione al servizio dei nostri tiratori, dando il giusto valore ad estetica ed eleganza: punti di forza che ci hanno contraddistinto sino ad oggi.

Nel progetto "DTS" sono contenuti diversi studi: le bindelle superiori regolabili montate sui fucili da tiro; le canne rigate per fucili Express dotate del dispositivo che consente la regolazione della rosata; il calcio da tiro con nasello pluridirezionale, sia in legno che in gomma morbida "No Impact"; i dispositivi "DTS Kinetic Balancer" sia per il calcio che per la canna utili non solo per la regolazione del bilanciamento dell'arma ma anche alla riduzione del rinculo.

Our "DTS" ("Dynamic Tuning System") project is the result of incredible engineering efforts coupled with substantial investments in R&D. Through the "DTS" project, we create technologically advanced solutions to meet the demand of very sophisticated shooters who want custom solutions.



DYNAMIC TUNING SYSTEM

We use technology and innovation to better serve our customers without ever neglecting cosmetics and elegance, our strengths so far. The "DTS" project covers several studies: adjustable top ribs on our sporting guns; rifled bore barrels provided with a system which allows one to change regulation for different loads on our double rifles; comb adjustable in several directions in either wood or soft "No Impact" rubber on our sporting shotguns; "DTS Kinetic Balancer" devices for either stocks and barrels which not only make it possible to better balance the shotgun, but also reduce felt recoil.

Lo scopo principale di queste bindelle, in funzione della loro altezza, è quello di fornire al tiratore un'ampia visibilità del bersaglio e una corretta postura durante il puntamento, nonché la massima possibilità di regolazione del punto d'impatto della rosata attraverso la bindella e il calcio "DTS". The main reason for these ribs, based on their height, is to give the shooter a very clear and open vision of the target and a correct aiming posture as well as the best regulation of the point of impact through the rib and the "DTS" stock.

Le bindelle regolabili sono divise in tre gruppi principali:

BINDELLE REGOLABILI AT

• Nate per i fucili solo in calibro 12 da competizione per l'American Trap e il Double Trap.

• Montate su canne sovrapposte e su canne Mono nelle versioni Top e Bottom, con la loro altezza di 25 mm, garantiscono la regolazione dell'altezza del punto d'impatto della rosata fino al 100%.

At present we have three main types of adjustable ribs:

"AT" ADJUSTABLE RIBS:

• They have been specifically studied and engineered for our American Trap and Double Trap shotguns in 12 ga only;

• They fit both our over and under and our single barrels either in the "Top Single" or "Bottom Single" versions. They are 25-mm high and allow 100% regulation of the point of impact.

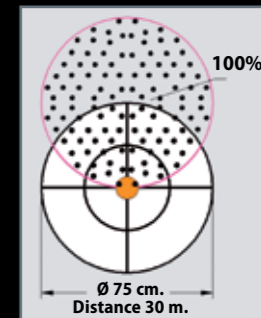

BINDELLE REGOLABILI IMPACT

• L'obiettivo, in questo caso molto ambizioso, è stato quello di proporre un nuovo approccio, tra tiratore e arma, attraverso la completa customizzazione del proprio fucile per i professionisti del mondo del Trap e dello Sporting, tradizionalmente riluttanti a modificare le proprie abitudini di tiro e che da sempre preferiscono i fucili di tipo tradizionale.

• Nate per fucili sia in calibro 12 che in calibro 20, sono indicate per le discipline Trap e Sporting.

La minima altezza di 17 mm ottenuta per la bindella superiore offre al tiratore la stessa sensazione che avverte sparando con un fucile provvisto della bindella tradizionale, in pratica, usare un fucile che adotta la tecnologia "Impact", fornisce senza alcun dubbio, un notevole vantaggio proprio per quelle discipline sportive che da sempre adottano solo fucili di tipo tradizionale.

• Esse garantiscono la regolazione dell'altezza del punto d'impatto della rosata fino al 80%.

"IMPACT" ADJUSTABLE RIBS

• We had the very ambitious project to create a new approach between shooter and firearm. We wanted to offer trap and sporting shooters, who are generally traditional and reluctant to change their shooting habits, the possibility to fully customize their shotguns.

• These ribs have been studied and engineered for our Trap and Sporting shotguns in both 12ga and 20ga.

The minimum possible height of 17mm of the top rib makes it possible for the shooter to feel the same way he would feel with a traditional rib while shooting.

In other words there is no doubt that shooting a gun built with the "Impact" technology offers a big advantage especially in those sporting disciplines where only traditional shotguns have been used so far.

• They allow 80% regulation of the point of impact.

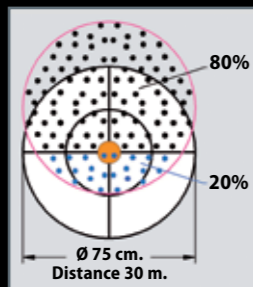

BINDELLE REGOLABILI EVOLUTION

• Il progetto "DTS" Bindelle regolabili si è recentemente arricchito di un altro importante prodotto, il modello Evolution.

Le caratteristiche tecniche e la regolazione ricordano quelle del modello da tiro Impact. La nuova bindella regolabile alta appena 14 mm è dotata di un sistema di attenuazione delle vibrazioni posizionato a metà della canna.

• La regolazione dell'altezza del punto d'impatto della rosata è stata ridotta a 50/50%-70/30% permettendo così anche la riduzione dell'altezza totale della bindella superiore.

• L'Evolution è la bindella regolabile più bassa offerta oggi sul mercato.

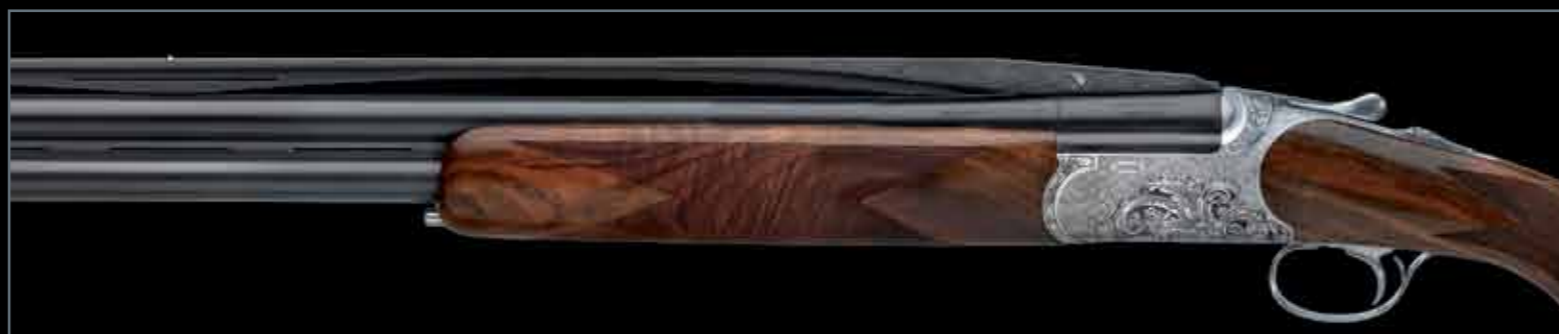

"EVOLUTION" ADJUSTABLE RIBS

• An additional and very important product has been recently added to our "DTS" adjustable rib project: the model Evolution. The technical features and adjustability are reminiscent of the Sporting shotgun model Impact. However the new adjustable rib is only 14mm high and comes with a vibration dampening system located midway on the barrel.

• The range of adjustability has been reduced to 50/50% - 70/30% point-of-impact allowing the total height of the top rib to be reduced.

• The Evolution is the lowest height adjustable rib on the market today.

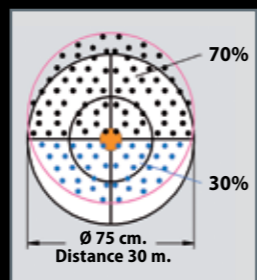

I fucili da tiro con la bindella elevata sono molto richiesti dai tiratori di oggi, ma non tutti hanno bisogno della regolazione estrema offerta su alcuni dei fucili Caesar Guerini. Il nuovo Ascent ne è la risposta.

Permette di soddisfare le esigenze del tiratore che desidera un approccio minimalista: offrendo una bindella alta e conica con un calcio DTS Monte Carlo.

Le canne e il calcio sono stati studiati in modo tale da permettere al tiratore di bilanciare

il fucile perfettamente tra le mani e renderlo più maneggevole.

High rib competition shotguns are in demand by the modern competitor, but not everyone needs the extreme adjustability offered on some of the current Caesar Guerini shotguns.

The new Ascent is the answer for the shooter that desires a minimalist approach, but wants a higher, tapered rib and DTS Monte Carlo stock. The barrel and stock have been tuned to make



the shotgun balance between the hands for improved handling.

Nelle canne dei fucili Express sovrapposte oltre ad aver progettato la bindella superiore con una forma conica ed averla equipaggiata con organi di mira regolabili ad alta fluorescenza, il cliente ha la possibilità di attrezzare il proprio fucile con l'ottica a lui più congeniale, semplicemente rimuovendo le due piastrine poste sulla bindella superiore. Anche in questo caso l'applicazione del progetto "DTS" è stata quella di fornire al cliente la possibilità di tarare il punto d'impatto della rosata, in funzione della munizione da lui ritenuta più idonea. Nella parte del vivo di volata è stato, infatti progettato e brevettato dall'azienda un inserto intercambiabile in acciaio speciale al cromo vanadio tenuto da due viti contrapposte che consente la regolazione della rosata.

Our O/U Express rifle barrels come with specifically designed tapered top ribs provided not only with adjustable, highly fluorescent sights but also with two fast detachable bases which enable our customers to use the scope of their choice.

Once again our "DTS" project has made it possible for our customers to get the desired point of impact based on the ammunition of their choice.

As a matter of fact, we have designed and patented an interchangeable vanadium-chrome steel insert held in place in the muzzle area by two screws, which enables shooters to get the desired barrel regulation.

Il calcio "DTS" è dotato di un nasello regolabile pluridirezionale che permette la regolazione in 7 micrometriche direzioni.

E' disponibile sia in legno che, a richiesta, in gomma morbida "No Impact" ed entrambe le versioni sono completamente intercambiabili tra loro.

Il calcio, è inoltre provvisto della sede per l'alloggiamento del "DTS Kinetic Balancer", disponibile a richiesta, sistema questo che grazie all'impiego di tre pesi bilanciatori frapposti a due molle, permette un bilanciamento ottimale e personalizzato, offrendo una notevole diminuzione del rinculo, a tutto vantaggio della stabilità dell'arma.

Our multidirectional "DTS" stock comb allows for 7 micrometric adjustments. It comes in wood and, on request, in "No Impact" soft rubber.

Both versions are fully interchangeable. The stock is also designed to fit the "DTS Kinetic Balancer" available on request.

Thanks to three weights positioned between two springs each shooter can actually choose the perfect balance of his shooting tool, with a substantial reduction of recoil while shooting to the benefit of overall shotgun stability.

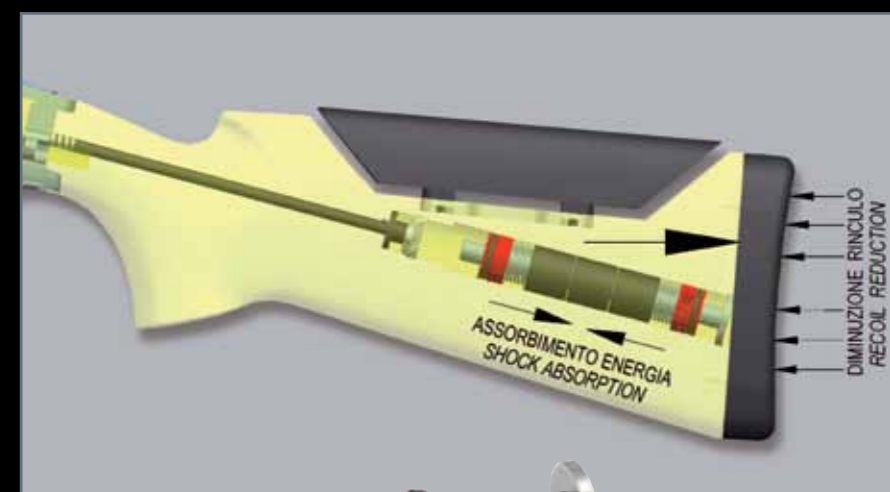

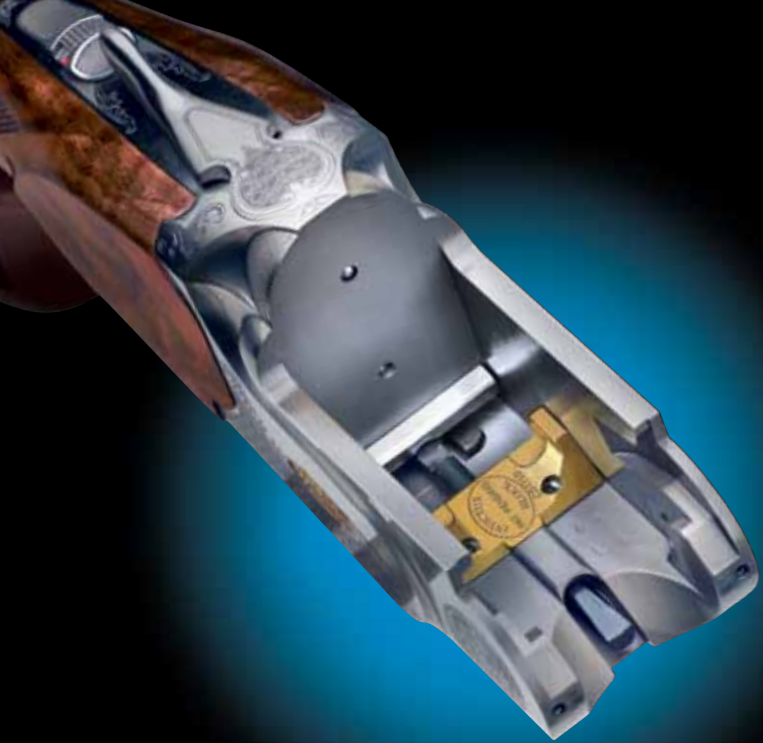

INVICTUS SYSTEM

Tutte le armi basculanti, in generale, dopo un uso intenso evidenziano qualche gioco nelle chiusure dovute a vari fattori, tra i quali i più conosciuti sono:

- L'usura del tassello di chiusura, osservabile dalla posizione della chiave di apertura che tende verso l'asse della bascula.
- L'usura dell'aggancio della croce con il tenone della canna, che si manifesta attraverso lassità in fase di apertura o chiusura.
- Il cedimento dell'accoppiamento della canna con i perni cerniera dovuto alle sollecitazioni che nello sparo tendono a staccare la canna dalla culatta della bascula, forzando sui perni cerniera ed in contemporanea anche sul rampone di chiusura in qualsiasi posizione esso si trovi (inferiore, superiore, laterale).

Generally speaking, all locking elements in hinge or pivot-barrel firearms will show signs of wear due to use. The most common are:

- Wear of the locking bolt, which causes a misalignment of the top lever.
 - Wear of the fore-end iron, which causes sloppy opening and closing.
 - Play between receiver and barrels in the hinge pin areas. The stress generated by the shooting tends to separate the barrel from the receiver thus putting a lot of pressure on hinges and lug regardless of its position (lower, top, side).
- Su tutte le armi moderne prodotte a livello industriale, a prescindere dalla tipologia e dallo stato di usura riscontrato, i servizi di assistenza delle Aziende intervengono con

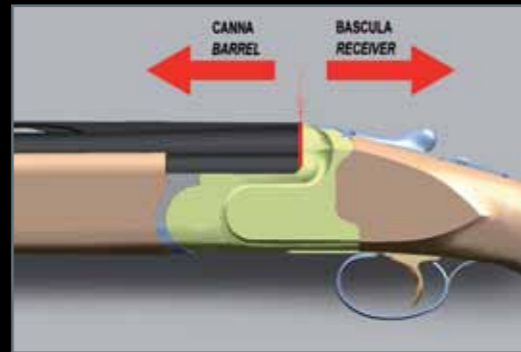

attività di recupero in modalità singola o abbinate, quali:

- La sostituzione del tassello di chiusura, possibile sulla quasi totalità delle armi;
- Il ripristino del tiraggio, oltre al tassello di chiusura, su un numero più limitato di armi;
- Per ultimo, e solo su poche armi, è anche possibile eseguire la sostituzione dei perni cerniera quando proposti come "intercambiabili". Va comunque ricordato che la sostituzione risulta essere assai difficoltosa ed alle volte impraticabile dalla maggior parte di riparatori autorizzati per motivi tecnici (impiego di attrezzature specifiche per lo smontaggio ed il rimontaggio, riscaldamento della zona per facilitare la rimozione dei perni, danneggiamento del trattamento superficiale) e anche per motivi puramente estetici con l'impossibilità di rispettare l'incisione originale della bascula.

Questi interventi risolvono in gran parte le problematiche, ma non permettono comunque il pieno ripristino dell'arma allo stato iniziale, indipendentemente dalla tipologia e dalla posizione dei ramponi (inferiori, superiori o laterali).

All modern industrial firearm manufacturers organize service centers to regularly service their products regardless of the condition and amount of wear they show. Service can be either specific to a component or more general, for example:

- Replacement of a locking lug required on almost all firearms;



Reducing the gap/play in the hinge pin area required on fewer guns;

Replacement of the hinge pins/trunnions, which is possible only when the parts are truly interchangeable. Fewer manufacturers offer this option and the replacement is very difficult to perform. Most authorized gun smiths are not in a position to carry out the substitution due to technical limitations (lack of specific tools to disassemble and reassemble the guns, ability to correctly heat up the hinge pin area to facilitate removal of the pins, damage to the surface treatment etc) as well as the fear of permanently and irreparably altering the look of the firearm by damaging its engraving.

Servicing often solves the issue experienced with the guns, but it never really brings the guns back to the original condition regardless of the type of locking system (lower, upper or side locking lugs).

La soluzione globale è INVICTUS SYSTEM

Con questo innovativo progetto, grazie agli INVICTUS CAM fissati sulla canna e non sulla bascula, sostituire i perni cerniera è diventato di facile esecuzione anche da personale non altamente specializzato e senza l'ausilio di attrezzature particolari. INVICTUS SYSTEM va oltre: dopo aver sostituito gli INVICTUS CAM, infatti, il progetto permette anche di ripristinare la chiusura del rampone infero-laterale della

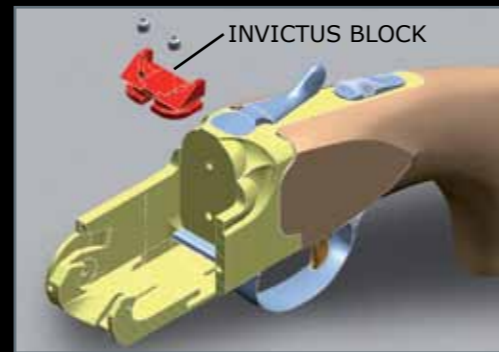

canna abbinando anche la sostituzione dell'INVICTUS BLOCK, ottenendo in questo modo il completo ripristino dell'arma allo stato di "COME NUOVA".

Per aumentare il confort del tiratore in pedana durante l'operazione di apertura e chiusura dell'arma, la croce è stata progettata con un nuovo dispositivo brevettato, denominato DTS ACTION CONTROL SYSTEM: esso consente, con una comune chiave a brugola, fornita in dotazione con l'arma, una rapida e micrometrica regolazione della frizione, garantendo, anche a fronte di inevitabili cambiamenti nel tempo, una forza costante. Sarà quindi il tiratore stesso, a decidere il suo personale grado di frizione, senza più alcun compromesso tra fucili nuovi solitamente troppo duri ed armi usate logicamente troppo lasse.

The only true and total solution is the INVICTUS SYSTEM

With this revolutionary system, the INVICTUS CAMS take the place of trunnions and are fixed to the barrel monoblock, not the action. Replacement is now much easier for gunsmiths without specific technical training or specialized tools. The INVICTUS SYSTEM does not stop at the hinge replacement, but it goes above and beyond. As a matter of fact it makes it possible to eliminate any play in the lower barrel lug area

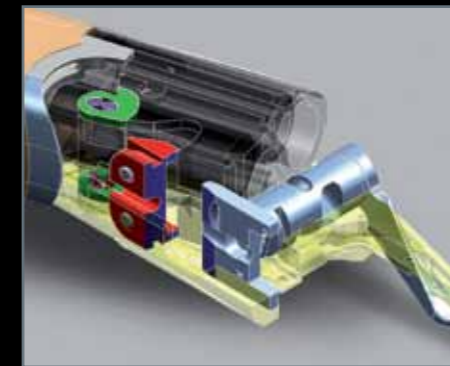

by replacing the INVICTUS BLOCK - the gun is now like new!

In order to improve competition shooters' comfort while opening and closing their shotguns, the fore-end iron has been re-designed to include a newly patented mechanism called the DTS ACTION CONTROL SYSTEM. By using a 3 mm Allen wrench that comes with every shotgun, shooters are now able to make adjustments to increase or decrease the friction between the fore-end and action. This allows the gun to open easier if desired or can be used to compensate for wear over time. Additionally, the surface area between the fore-end iron and barrel lug has been increased resulting in enhanced durability. Each shooter is now in complete control of the opening and closing force and no longer needs to compromise with a shotgun that is either too hard when new or too loose when old.

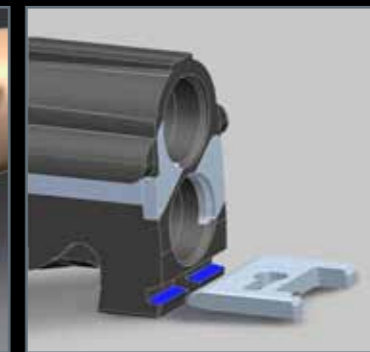

Pronta per il traguardo di 1 milione di colpi...

INVICTUS, infatti, significa anche una superficie del tassello di chiusura e dei ramponi di tenuta più ampia di quelle presenti su tutti i fucili industriali del mercato di larga scala.

Ready to fire 1 million rounds ...

INVICTUS also offers substantially bigger locking surfaces than any other industrial firearm on the market today.



FUCILI DA TIRO A VOLO COMPETITION SHOTGUNS

- Pag. 16 TEMPER, SUMMIT, SUMMIT BLACK
- Pag. 20 CHALLENGER
- Pag. 22 MAGNUS
- Pag. 24 MAXUM
- Pag. 26 APEX
- Pag. 28 FORUM
- Pag. 30 ELLIPSE EVO, ELLIPSE CURVE
- Pag. 32 INVICTUS I
- Pag. 34 INVICTUS III
- Pag. 36 INVICTUS V
- Pag. 38 INVICTUS VII

FUCILI DA CACCIA FIELD SHOTGUNS

- Pag. 40 FIGURA, FIGURA LIGHT
 - Pag. 42 TEMPIO, TEMPIO LIGHT
 - Pag. 44 MAGNUS LIMITED , MAGNUS LIGHT
 - Pag. 46 MAXUM
 - Pag. 48 APEX
 - Pag. 50 FORUM
 - Pag. 52 ELLIPSE EVO, ELLIPSE EVO LIGHT, ELLIPSE CURVE, ELLIPSE CURVE GOLD
 - Pag. 54 REVENANT
 - Pag. 56 EXPRESS TROFEO, EXPRESS REFLEXO, EXPRESS MAXUM, EXPRESS ELLIPSE EVO, EXPRESS ELLIPSE EVO LIGHT
-
- Pag. 60 ROMAN MMI
ROMAN MMV
ROMAN MMX
GLADIUS
-
- Pag. 64 Accessori
Accessories

Sovrapposti tiro Over and under competition shotguns



Sovrapposti caccia Over and under field shotguns



Semiautomatici Semiautomatic shotguns



Incisione manuale
Hand engraving



Rivestimento superficiale
Invisalloy
Invisalloy surface treatment



Fucile superleggero
Extra light shotgun



Prova forzata di resistenza
High pressure test



Omologazione arma per impiego di pallini d'acciaio
Steel shot homologation



Dynamic Tuning System



Canna con cono di raccordo tra camera e anima
Barrels provided with "DueCon" cone between chambers and bore

maxisBORE

Anima con geometria speciale
Special structure bore

maxisCHOKE

Strozzatore speciale
Special choke



Strozzatura fissa
Fixed choke



Temper - Summit - Summit Black



TEMPER TRAP



MODELLO MODEL	CALIBRO GAUGE	CAMERA CHAMBER	LUNGH. CANNE BARRELS LENGTH	BINDELLA SUP. TOP RIB	BINDELLA LAT. SIDE RIB	SICURA SAFETY	PESO* WEIGHT*	PIEGA DROP	LUNGH. CALCIO STOCK LENGTH	CALCIOLO PAD	IMBALLO PACKING	MIRINO SIGHT	STROZZATURE CHOKES
TEMPER SPORTING	12	70 mm DueCon maxisBORE	71/76/81/86	Conica ventilata Tapered ventilated	Ventilata Ventilated	Selettiva Selective	Kg 3,7	35/55 mm	377 mm	Gomma pieno Full Rubber	Valigetta ABSPRO ABSPRO case	Bianco sferico White spherical	maxis CHOKE COMPETITION
TEMPER TRAP	12	70 mm DueCon maxisBORE	76/81	Conica ventilata Tapered ventilated	Ventilata Ventilated	Fissa Fixed	Kg 3,7	31/41 mm	377 mm	Gomma ventilato Ventilated rubber	Valigetta ABSPRO ABSPRO case	Bianco sferico White spherical	maxis CHOKE COMPETITION
SUMMIT SPORTING	12	70 mm DueCon maxisBORE	71/76/81/86	Conica ventilata Tapered ventilated	Ventilata Ventilated	Selettiva Selective	Kg 3,7	35/55 mm	377 mm	Gomma pieno Full Rubber	Valigetta ABSPRO ABSPRO case	Bianco sferico White spherical	maxis CHOKE COMPETITION
	20	70 mm DueCon maxisBORE	71/76/81	10 mm									SELECTACHOKE SPORTING
	28	70 mm	76/81	8 mm	Intera Full	Kg 3,4							
SUMMIT SPORTING COMPACT	12	70 mm DueCon maxisBORE	71/76/81/86	Conica ventilata Tapered ventilated	Ventilata Ventilated	Selettiva Selective	Kg 3,65	35/45/64 mm	356 mm	Gomma pieno Full Rubber	Valigetta ABSPRO ABSPRO case	Bianco sferico White spherical	maxis CHOKE COMPETITION
	20	70 mm DueCon maxisBORE	71/76/81	10 mm									SELECTACHOKE SPORTING
	28	70 mm	76/81	8 mm	Intera Full	Kg 3,3							
SUMMIT TRAP	12	70 mm DueCon maxisBORE	76/81	Conica ventilata Tapered ventilated	Ventilata Ventilated	Fissa Fixed	Kg 3,7	31/41 mm	377 mm	Gomma ventilato Ventilated rubber	Valigetta ABSPRO ABSPRO case	Bianco sferico White spherical	maxis CHOKE COMPETITION
SUMMIT TRAP AT	12	70 mm DueCon maxisBORE	76/81	Conica ventilata Tapered ventilated	Ventilata Ventilated	Fissa Fixed	Kg 3,85	DTS	377 mm	Gomma ventilato Ventilated rubber	Valigetta ABSPRO ABSPRO case	Bianco sferico White spherical	maxis CHOKE COMPETITION
SUMMIT TRAP AT U/S B.	12	70 mm DueCon maxisBORE	81/86	Conica ventilata Tapered ventilated	Ventilata Ventilated	Fissa Fixed	Kg 3,85	DTS	377 mm	Gomma ventilato Ventilated rubber	Valigetta ABSPRO ABSPRO case	Bianco sferico White spherical	maxis CHOKE COMPETITION
SUMMIT TRAP AT U/S T.	12	70 mm DueCon maxisBORE	86	Conica ventilata Tapered ventilated	Ventilata Ventilated	Selettiva Selective	Kg 3,85	DTS	377 mm	Gomma ventilato Ventilated rubber	Valigetta ABSPRO ABSPRO case	Bianco sferico White spherical	maxis CHOKE COMPETITION
SUMMIT BLACK IMPACT SPORTING	12	70 mm DueCon maxisBORE	71/73/76/81/86	Conica ventilata Tapered ventilated	Ventilata Ventilated	Selettiva Selective	Kg 3,85	DTS	377 mm	Gomma pieno Full Rubber	Valigetta ABSPRO ABSPRO case	Bianco sferico White spherical	maxis CHOKE COMPETITION
	20	70 mm DueCon maxisBORE	76/81										SELECTACHOKE SPORTING
SUMMIT BLACK IMPACT TRAP	12	70 mm DueCon maxisBORE	76/81	Conica ventilata Tapered ventilated	Ventilata Ventilated	Fissa Fixed	Kg 3,85	DTS	377 mm	Gomma pieno Full Rubber	Valigetta ABSPRO ABSPRO case	Bianco sferico White spherical	maxis CHOKE COMPETITION
SUMMIT BLACK ASCENT TRAP	12	70 mm DueCon maxisBORE	76/81	Conica ventilata Tapered ventilated	Ventilata Ventilated	Fissa Fixed	Kg 3,75	DTS	377 mm	Gomma pieno Full Rubber	Valigetta ABSPRO ABSPRO case	Bianco sferico White spherical	maxis CHOKE COMPETITION
SUMMIT BLACK ASCENT SPORTING	12	70 mm DueCon maxisBORE	76/81	Conica ventilata Tapered ventilated	Ventilata Ventilated	Selettiva Selective	Kg 3,75	DTS	377 mm	Gomma pieno Full Rubber	Valigetta ABSPRO ABSPRO case	Bianco sferico White spherical	maxis CHOKE COMPETITION

*I pesi sono calcolati mediamente con canne da 76 e calci di densità standard. Nell'imballo chiavi smontaggio calcio e regolazione grilletto inclusi.

*Weights are calculated with 76 cm barrels and standard stocks. Each gun comes with wrenches to remove the stock and adjust the trigger



A RICHIESTA NEI cal. 12 e 20 ON REQUEST 12 AND 20 ga.

Temper - Summit - Summit Black



SUMMIT TRAP



SUMMIT BLACK IMPACT SPORTING **DTS**



SUMMIT BLACK ASCENT SPORTING **DTS**



SUMMIT SPORTING COMPACT



SUMMIT TRAP AT **DTS**



SUMMIT TRAP AT U/S B. **DTS**



SUMMIT TRAP AT U/S T. **DTS**

Challenger



MODELLO MODEL	CALIBRO GAUGE	CAMERA CHAMBER	LUNGH. CANNE BARRELS LENGTH	BINDELLA SUP. TOP RIB	BINDELLA LAT. SIDE RIB	SICURA SAFETY	PESO* WEIGHT*	PIEGA DROP	LUNGH. CALCIO STOCK LENGTH	CALCIOLO PAD	IMBALLO PACKING	MIRINO SIGHT	STROZZATURE CHOKES
CHALLENGER SPORTING	12	70 mm <i>maxisBORE</i>	71/76/81/86	Conica ventilata Tapered ventilated	Ventilata Ventilated	Selettiva Selective	Kg 3,7	35/55 mm	377 mm	Gomma pieno Full rubber	Valigetta ABS PRO ABS PRO case	Bianco sferico White spherical	<i>maxisCHOKE</i> COMPETITION
CHALLENGER TRAP	12	70 mm <i>maxisBORE</i>	76/81	Conica ventilata Tapered ventilated	Ventilata Ventilated	Fissa Fixed	Kg 3,7	31/41 mm	377 mm	Gomma ventilato Ventilated rubber	Valigetta ABS PRO ABS PRO case	Bianco sferico White spherical	<i>maxisCHOKE</i> COMPETITION
CHALLENGER TRAP AT	12	70 mm <i>maxisBORE</i>	76/81	Conica ventilata Tapered ventilated	Ventilata Ventilated	Fissa Fixed	Kg 3,85		377 mm	Gomma ventilato Ventilated rubber	Valigetta ABS PRO ABS PRO case	Bianco sferico White spherical	<i>maxisCHOKE</i> COMPETITION
CHALLENGER IMPACT SPORTING	12	70 mm <i>maxisBORE</i>	71/73/76/81/86	Conica ventilata Tapered ventilated	Ventilata Ventilated	Selettiva Selective	Kg 3,85		377 mm	Gomma pieno Full rubber	Valigetta ABS PRO ABS PRO case	Bianco sferico White spherical	<i>maxisCHOKE</i> COMPETITION
CHALLENGER IMPACT TRAP	12	70 mm <i>maxisBORE</i>	76/81	Conica ventilata Tapered ventilated	Ventilata Ventilated	Fissa Fixed	Kg 3,85		377 mm	Gomma pieno Full rubber	Valigetta ABS PRO ABS PRO case	Bianco sferico White spherical	<i>maxisCHOKE</i> COMPETITION
CHALLENGER ASCENT SPORTING	12	70 mm <i>maxisBORE</i>	76/81	Conica ventilata Tapered ventilated	Ventilata Ventilated	Selettiva Selective	Kg 3,75		377 mm	Gomma pieno Full rubber	Valigetta ABS PRO ABS PRO case	Bianco sferico White spherical	<i>maxisCHOKE</i> COMPETITION
CHALLENGER ASCENT TRAP	12	70 mm <i>maxisBORE</i>	76/81	Conica ventilata Tapered ventilated	Ventilata Ventilated	Fissa Fixed	Kg 3,75		377 mm	Gomma pieno Full rubber	Valigetta ABS PRO ABS PRO case	Bianco sferico White spherical	<i>maxisCHOKE</i> COMPETITION

* I pesi sono calcolati mediamente con canne da 76 e calci di densità standard. Nell'imballo chiavi smontaggio calcio e regolazione grilletto inclusi.

* Weights are calculated with 76 cm barrels and standard stocks. Each gun comes with wrenches to remove the stock and adjust the trigger

STEEL SHOT
STEEL SHOT



A RICHIESTA
ON REQUEST



CHALLENGER SPORTING



CHALLENGER IMPACT SPORTING



CHALLENGER ASCENT SPORTING



CHALLENGER TRAP AT

Magnus



MODELLO MODEL	CALIBRO GAUGE	CAMERA CHAMBER	LUNGH. CANNE BARRELS LENGTH	BINDELLA SUP. TOP RIB	BINDELLA LAT. SIDE RIB	SICURA SAFETY	PESO* WEIGHT*	PIEGA DROP	LUNGH. CALCIO STOCK LENGTH	CALCIOLO PAD	IMBALLO PACKING	MIRINO SIGHT	STROZZATURE CHOKES
MAGNUS SPORTING	12	70 mm <i>maxis</i> BORE	71/76/81/86	Conica ventilata <i>Tapered ventilated</i>	Ventilata <i>Ventilated</i>	Selettiva <i>Selective</i>	Kg 3,75	35/55 mm	377 mm	Gomma pieno <i>Full rubber</i>	Valigetta ABSPRO <i>ABSPRO case</i>	Bianco sferico <i>White spherical</i>	<i>maxis</i> CHOKE COMPETITION
	20	70 mm <i>maxis</i> BORE	71/76/81	10 mm			SELETTACHOKE SPORTING						
	28	70 mm	76/81	8 mm	Intera <i>Full</i>								
	36	76 mm											
MAGNUS TRAP	12	70 mm <i>maxis</i> BORE	76/81	Conica ventilata <i>Tapered ventilated</i>	Ventilata <i>Ventilated</i>	Fissa <i>Fixed</i>	Kg 3,7	31/41 mm	377 mm	Gomma ventilato <i>Ventilated rubber</i>	Valigetta ABSPRO <i>ABSPRO case</i>	Bianco sferico <i>White spherical</i>	<i>maxis</i> CHOKE COMPETITION
MAGNUS TRAP AT	12	70 mm <i>maxis</i> BORE	76/81	Conica ventilata <i>Tapered ventilated</i>	Ventilata <i>Ventilated</i>	Fissa <i>Fixed</i>	Kg 3,9		377 mm	Gomma ventilato <i>Ventilated rubber</i>	Valigetta ABSPRO <i>ABSPRO case</i>	Bianco sferico <i>White spherical</i>	<i>maxis</i> CHOKE COMPETITION
MAGNUS IMPACT TRAP	12	70 mm <i>maxis</i> BORE	76/81	Conica ventilata <i>Tapered ventilated</i>	Ventilata <i>Ventilated</i>	Fissa <i>Fixed</i>	Kg 3,85		377 mm	Gomma pieno <i>Full rubber</i>	Valigetta ABSPRO <i>ABSPRO case</i>	Bianco sferico <i>White spherical</i>	<i>maxis</i> CHOKE COMPETITION
MAGNUS IMPACT SPORTING	12	70 mm <i>maxis</i> BORE	71/73/76/81/86	Conica ventilata <i>Tapered ventilated</i>	Ventilata <i>Ventilated</i>	Selettiva <i>Selective</i>	Kg 3,85		377 mm	Gomma pieno <i>Full rubber</i>	Valigetta ABSPRO <i>ABSPRO case</i>	Bianco sferico <i>White spherical</i>	<i>maxis</i> CHOKE COMPETITION
	20	70 mm <i>maxis</i> BORE	76/81				Kg 3,55						SELETTACHOKE SPORTING



MAGNUS SPORTING



MAGNUS TRAP AT



MAGNUS IMPACT TRAP

* I pesi sono calcolati mediamente con canne da 76 e calci di densità standard. Nell'imballo chiavi smontaggio calcio e regolazione grilletto inclusi.

STEEL SHOT
STEEL SHOT



A RICHIESTA NEI cal. 12 e 20
ON REQUEST 12 AND 20 ga.

Maxum



MODELLO MODEL	CALIBRO GAUGE	CAMERA CHAMBER	LUNGH. CANNE BARRELS LENGTH	BINDELLA SUP. TOP RIB	BINDELLA LAT. SIDE RIB	SICURA SAFETY	PESO* WEIGHT*	PIEGA DROP	LUNGH. CALCIO STOCK LENGTH	CALCIOLO PAD	IMBALLO PACKING	MIRINO SIGHT	STROZZATURE CHOKES
MAXUM SPORTING	12	70 mm <i>maxisBORE</i>	71/76/81/86	Conica ventilata <i>Tapered ventilated</i>	Ventilata <i>Ventilated</i>	Selettiva <i>Selective</i>	Kg 3,75	35/55 mm	377 mm	Gomma pieno <i>Full rubber</i>	Valigetta ABSPRO <i>ABSPRO case</i>	Bianco sferico <i>White spherical</i>	<i>maxisCHOKE</i> COMPETITION
	20	70 mm <i>maxisBORE</i>	71/76/81	10 mm			Kg 3,75						SELECTACHOKE SPORTING
	28	70 mm	76/81	8 mm	Intera <i>Full</i>								
	36	76 mm											
MAXUM TRAP	12	70 mm <i>maxisBORE</i>	76/81	Conica ventilata <i>Tapered ventilated</i>	Ventilata <i>Ventilated</i>	Fissa <i>Fixed</i>	Kg 3,7	31/41 mm	377 mm	Gomma ventilato <i>Ventilated rubber</i>	Valigetta ABSPRO <i>ABSPRO case</i>	Bianco sferico <i>White spherical</i>	<i>maxisCHOKE</i> COMPETITION
MAXUM TRAP AT	12	70 mm <i>maxisBORE</i>	76/81	Conica ventilata <i>Tapered ventilated</i>	Ventilata <i>Ventilated</i>	Fissa <i>Fixed</i>	Kg 3,9		377 mm	Gomma ventilato <i>Ventilated rubber</i>	Valigetta ABSPRO <i>ABSPRO case</i>	Bianco sferico <i>White spherical</i>	<i>maxisCHOKE</i> COMPETITION
MAXUM IMPACT SPORTING	12	70 mm <i>maxisBORE</i>	71/73/76/81/86	Conica ventilata <i>Tapered ventilated</i>	Ventilata <i>Ventilated</i>	Selettiva <i>Selective</i>	Kg 3,85		377 mm	Gomma pieno <i>Full rubber</i>	Valigetta ABSPRO <i>ABSPRO case</i>	Bianco sferico <i>White spherical</i>	<i>maxisCHOKE</i> COMPETITION
	20	70 mm <i>maxisBORE</i>	76/81	SELECTACHOKE SPORTING									
MAXUM IMPACT TRAP	12	70 mm <i>maxisBORE</i>	76/81	Conica ventilata <i>Tapered ventilated</i>	Ventilata <i>Ventilated</i>	Fissa <i>Fixed</i>	Kg 3,85		377 mm	Gomma pieno <i>Full rubber</i>	Valigetta ABSPRO <i>ABSPRO case</i>	Bianco sferico <i>White spherical</i>	<i>maxisCHOKE</i> COMPETITION



MAXUM SPORTING



MAXUM TRAP AT



MAXUM IMPACT TRAP

* I pesi sono calcolati mediamente con canne da 76 e calci di densità standard. Nell'imballo chiavi smontaggio calcio e regolazione grilletto inclusi.

STEEL SHOT
STEEL SHOT



A RICHIESTA NEI cal. 12 e 20
ON REQUEST 12 AND 20 ga.

* Weights are calculated with 76 cm barrels and standard stocks. Each gun comes with wrenches to remove the stock and adjust the trigger

Apex



MODELLO MODEL	CALIBRO GAUGE	CAMERA CHAMBER	LUNGH. CANNE BARRELS LENGTH	BINDELLA SUP. TOP RIB	BINDELLA LAT. SIDE RIB	SICURA SAFETY	PESO* WEIGHT*	PIEGA DROP	LUNGH. CALCIO STOCK LENGTH	CALCIOLO PAD	IMBALLO PACKING	MIRINO SIGHT	STROZZATURE CHOKES
APEX SPORTING	12	70 mm DueCon <i>maxis</i> BORE	71/76/81/86	Conica ventilata Tapered ventilated	Ventilata Ventilated	Selettiva Selective	Kg 3,75	35/55 mm	377 mm	Gomma pieno Full rubber	Valigetta ABSPRO inserti in pelle ABSPRO leather accent case	Bianco sferico White spherical	<i>maxis</i> CHOKE COMPETITION
	20	70 mm DueCon <i>maxis</i> BORE	71/76/81	10 mm			Intera Full						Kg 3,75
	28	70 mm	76/81	8 mm	SELECTACHOKE SPORTING								
	36	76 mm			SELECTACHOKE SPORTING								
APEX TRAP	12	70 mm DueCon <i>maxis</i> BORE	76/81	Conica ventilata Tapered ventilated	Ventilata Ventilated	Fissa Fixed	Kg 3,7	31/41 mm	377 mm	Gomma ventilato Ventilated rubber	Valigetta ABSPRO inserti in pelle ABSPRO leather accent case	Bianco sferico White spherical	<i>maxis</i> CHOKE COMPETITION
APEX TRAP AT	12	70 mm DueCon <i>maxis</i> BORE	76/81	Conica ventilata Tapered ventilated	Ventilata Ventilated	Fissa Fixed	Kg 3,9	DTS	377 mm	Gomma ventilato Ventilated rubber	Valigetta ABSPRO inserti in pelle ABSPRO leather accent case	Bianco sferico White spherical	<i>maxis</i> CHOKE COMPETITION
APEX IMPACT SPORTING	12	70 mm DueCon <i>maxis</i> BORE	71/73/76/81/86	Conica ventilata Tapered ventilated	Ventilata Ventilated	Selettiva Selective	Kg 3,85	DTS	377 mm	Gomma pieno Full rubber	Valigetta ABSPRO inserti in pelle ABSPRO leather accent case	Bianco sferico White spherical	<i>maxis</i> CHOKE COMPETITION
	20	70 mm DueCon <i>maxis</i> BORE	76/81	8 mm			Kg 3,55						SELECTACHOKE SPORTING
APEX IMPACT TRAP	12	70 mm DueCon <i>maxis</i> BORE	76/81	Conica ventilata Tapered ventilated	Ventilata Ventilated	Fissa Fixed	Kg 3,85	DTS	377 mm	Gomma pieno Full rubber	Valigetta ABSPRO inserti in pelle ABSPRO leather accent case	Bianco sferico White spherical	<i>maxis</i> CHOKE COMPETITION



APEX SPORTING



APEX TRAP AT



APEX IMPACT TRAP



* I pesi sono calcolati mediamente con canne da 76 e calci di densità standard. Nell'imballo chiavi smontaggio calcio e regolazione grilletto inclusi.



A RICHIESTA NEI cal. 12 e 20 ON REQUEST 12 AND 20 ga.

Forum



MODELLO MODEL	CALIBRO GAUGE	CAMERA CHAMBER	LUNGH. CANNE BARRELS LENGTH	BINDELLA SUP. TOP RIB	BINDELLA LAT. SIDE RIB	SICURA SAFETY	PESO* WEIGHT*	PIEGA DROP	LUNGH. CALCIO STOCK LENGTH	CALCIOLO PAD	IMBALLO PACKING	MIRINO SIGHT	STROZZATURE CHOKES	
FORUM SPORTING	12	70 mm maxisBORE	71/76/81/86	Conica ventilata Tapered ventilated	Ventilata Ventilated	Selettiva Selective	Kg 3,75	35/55 mm	377 mm	Gomma pieno Full rubber	Valigetta ABSPRO inserti in pelle ABSPRO leather accent case	Bianco sferico White spherical	maxisCHOKE COMPETITION	
	20	70 mm maxisBORE	71/76/81	10 mm			Intera Full						Kg 3,75	SELECTACHOKE SPORTING
	28	70 mm	76/81		8 mm									Kg 3,75
	36	76 mm		8 mm			Kg 3,75						SELECTACHOKE SPORTING	
FORUM TRAP	12	70 mm maxisBORE	76/81		Conica ventilata Tapered ventilated	Ventilata Ventilated		Fissa Fixed	Kg 3,7	31/41 mm	377 mm	Gomma ventilato Ventilated rubber		Valigetta ABSPRO inserti in pelle ABSPRO leather accent case
FORUM TRAP AT	12	70 mm maxisBORE	76/81	Conica ventilata Tapered ventilated	Ventilata Ventilated	Fissa Fixed	Kg 3,9		377 mm	377 mm	Gomma ventilato Ventilated rubber	Valigetta ABSPRO inserti in pelle ABSPRO leather accent case	Bianco sferico White spherical	maxisCHOKE COMPETITION
FORUM IMPACT SPORTING	12	70 mm maxisBORE	71/73/76/81/86	Conica ventilata Tapered ventilated	Ventilata Ventilated	Selettiva Selective	Kg 3,85		377 mm	Gomma pieno Full rubber	Valigetta ABSPRO inserti in pelle ABSPRO leather accent case	Bianco sferico White spherical	maxisCHOKE COMPETITION	
	20	70 mm maxisBORE	76/81	Conica ventilata Tapered ventilated			Kg 3,55						SELECTACHOKE SPORTING	
FORUM IMPACT TRAP	12	70 mm maxisBORE	76/81	Conica ventilata Tapered ventilated	Ventilata Ventilated	Fissa Fixed		Kg 3,85		377 mm	377 mm	Gomma pieno Full rubber		Valigetta ABSPRO inserti in pelle ABSPRO leather accent case

* I pesi sono calcolati mediamente con canne da 76 e calci di densità standard. Nell'imballo chiavi smontaggio calcio e regolazione grilletto inclusi.

STEEL SHOT
STEEL SHOT



A RICHIESTA NEI cal. 12 e 20
ON REQUEST 12 AND 20 ga.

* Weights are calculated with 76 cm barrels and standard stocks. Each gun comes with wrenches to remove the stock and adjust the trigger

FORUM SPORTING



FORUM TRAP AT



FORUM IMPACT TRAP



Ellipse Evo - Ellipse Curve



MODELLO MODEL	CALIBRO GAUGE	CAMERA CHAMBER	LUNGH. CANNE BARRELS LENGTH	BINDELLA SUP. TOP RIB	BINDELLA LAT. SIDE RIB	SICURA SAFETY	PESO* WEIGHT*	PIEGA DROP	LUNGH. CALCIO STOCK LENGTH	CALCIOLO PAD	IMBALLO PACKING	MIRINO SIGHT	STROZZATURE CHOKES
ELLIPSE EVO SPORTING	12	70 mm <i>maxis</i> BORE	76/81	Conica Ventilata <i>Tapered ventilated</i>	Ventilata <i>Ventilated</i>	Selettiva <i>Selective</i>	Kg 3,75	35/55 mm	377 mm	Gomma pieno <i>Full rubber</i>	Valigetta ABS PRO <i>ABS PRO case</i>	Bianco sferico <i>White spherical</i>	<i>maxis</i> CHOKE COMPETITION
ELLIPSE EVO TRAP	12	70 mm <i>maxis</i> BORE	76/81	Conica ventilata <i>Tapered ventilated</i>	Ventilata <i>Ventilated</i>	Fissa <i>Fixed</i>	Kg 3,75	31/41 mm	377 mm	Gomma Ventilato <i>Ventilated Rubber</i>	Valigetta ABS PRO <i>ABS PRO case</i>	Bianco sferico <i>White spherical</i>	<i>maxis</i> CHOKE COMPETITION
ELLIPSE EVOLUTION TRAP	12	70 mm <i>maxis</i> BORE	76/81	Conica Ventilata <i>Tapered ventilated</i>	Ventilata <i>Ventilated</i>	Fissa <i>Fixed</i>	Kg 3,9		377 mm	Gomma pieno <i>Full rubber</i>	Valigetta ABS PRO <i>ABS PRO case</i>	Bianco sferico <i>White spherical</i>	<i>maxis</i> CHOKE COMPETITION
ELLIPSE EVOLUTION SPORTING	12	70 mm <i>maxis</i> BORE	76/81	Conica Ventilata <i>Tapered ventilated</i>	Ventilata <i>Ventilated</i>	Selettiva <i>Selective</i>	Kg 3,9		377 mm	Gomma Pieno <i>Full rubber</i>	Valigetta ABS PRO <i>ABS PRO case</i>	Bianco sferico <i>White spherical</i>	<i>maxis</i> CHOKE COMPETITION
ELLIPSE EVO ASCENT TRAP	12	70 mm <i>maxis</i> BORE	76/81	Conica ventilata <i>Tapered ventilated</i>	Ventilata <i>Ventilated</i>	Fissa <i>Fixed</i>	Kg 3,9		377 mm	Gomma pieno <i>Full rubber</i>	Valigetta ABS PRO <i>ABS PRO case</i>	Bianco sferico <i>White spherical</i>	<i>maxis</i> CHOKE COMPETITION
ELLIPSE EVO ASCENT SPORTING	12	70 mm <i>maxis</i> BORE	76/81	Conica ventilata <i>Tapered ventilated</i>	Ventilata <i>Ventilated</i>	Selettiva <i>Selective</i>	Kg 3,9		377 mm	Gomma pieno <i>Full rubber</i>	Valigetta ABS PRO <i>ABS PRO case</i>	Bianco sferico <i>White spherical</i>	<i>maxis</i> CHOKE COMPETITION
ELLIPSE CURVE SPORTING	12	70 mm <i>maxis</i> BORE	76/81	Conica ventilata <i>Tapered ventilated</i>	Ventilata <i>Ventilated</i>	Selettiva <i>Selective</i>	Kg 3,75	35/55 mm	377 mm	Gomma pieno <i>Full rubber</i>	Valigetta ABS PRO <i>ABS PRO case</i>	Bianco sferico <i>White spherical</i>	<i>maxis</i> CHOKE COMPETITION
ELLIPSE CURVE ASCENT SPORTING	12	70 mm <i>maxis</i> BORE	76/81	Conica ventilata <i>Tapered ventilated</i>	Ventilata <i>Ventilated</i>	Selettiva <i>Selective</i>	Kg 3,9		377 mm	Gomma pieno <i>Full rubber</i>	Valigetta ABS PRO <i>ABS PRO case</i>	Bianco sferico <i>White spherical</i>	<i>maxis</i> CHOKE COMPETITION
ELLIPSE CURVE GOLD SPORTING	12	70 mm <i>maxis</i> BORE	76/81	Conica ventilata <i>Tapered ventilated</i>	Ventilata <i>Ventilated</i>	Selettiva <i>Selective</i>	Kg 3,75		377 mm	Gomma pieno <i>Full rubber</i>	Valigetta ABS PRO <i>ABS PRO case</i>	Bianco sferico <i>White spherical</i>	<i>maxis</i> CHOKE COMPETITION

* I pesi sono calcolati mediamente con canne da 76 e calci di densità standard. Nell'imballo chiavi smontaggio calcio e regolazione grilletto inclusi.

* Weights are calculated with 76 cm barrels and standard stocks. Each gun comes with wrenches to remove the stock and adjust the trigger

STEEL SHOT
STEEL SHOT



A RICHIESTA
ON REQUEST

ELLIPSE EVOLUTION SPORTING



ELLIPSE CURVE SPORTING

ELLIPSE CURVE GOLD SPORTING

ELLIPSE EVO ASCENT SPORTING





Invictus I



MODELLO MODEL	CALIBRO GAUGE	CAMERA CHAMBER	LUNGH. CANNE BARRELS LENGTH	BINDELLA SUP. TOP RIB	BINDELLA LAT. SIDE RIB	SICURA SAFETY	PESO* WEIGHT*	PIEGA DROP	LUNGH. CALCIO STOCK LENGTH	CALCIOLO PAD	IMBALLO PACKING	MIRINO SIGHT	STROZZATURE CHOKES
INVICTUS I SPORTING	12	70 mm DueCon <i>maxisBORE</i>	71/76/81	Conica Ventilata Tapered ventilated	Ventilata Ventilated	Selettiva Selective	Kg 3,75	35/55 mm	377 mm	Gomma pieno Full rubber	Valigetta ABSPRO ABSPRO case	Bianco sferico White spherical	<i>maxis</i> CHOKE COMPETITION
INVICTUS I TRAP	12	70 mm DueCon <i>maxisBORE</i>	76/81	Conica Ventilata Tapered ventilated	Ventilata Ventilated	Fissa Fixed	Kg 3,75	31/41 mm	377 mm	Gomma ventilato Ventilated rubber	Valigetta ABSPRO ABSPRO case	Bianco sferico White spherical	<i>maxis</i> CHOKE COMPETITION
INVICTUS I IMPACT SPORTING	12	70 mm DueCon <i>maxisBORE</i>	76/81	Conica Ventilata Tapered ventilated	Ventilata Ventilated	Selettiva Selective	Kg 3,9	DTS	377 mm	Gomma pieno Full rubber	Valigetta ABSPRO ABSPRO case	Bianco sferico White spherical	<i>maxis</i> CHOKE COMPETITION
INVICTUS I IMPACT TRAP	12	70 mm DueCon <i>maxisBORE</i>	76/81	Conica Ventilata Tapered ventilated	Ventilata Ventilated	Fissa Fixed	Kg 3,9	DTS	377 mm	Gomma pieno Full rubber	Valigetta ABSPRO ABSPRO case	Bianco sferico White spherical	<i>maxis</i> CHOKE COMPETITION
INVICTUS I ASCENT TRAP	12	70 mm DueCon <i>maxisBORE</i>	76/81	Conica Ventilata Tapered ventilated	Ventilata Ventilated	Fissa Fixed	Kg 3,9	DTS	377 mm	Gomma pieno Full rubber	Valigetta ABSPRO ABSPRO case	Bianco sferico White spherical	<i>maxis</i> CHOKE COMPETITION
INVICTUS I ASCENT SPORTING	12	70 mm DueCon <i>maxisBORE</i>	76/81	Conica Ventilata Tapered ventilated	Ventilata Ventilated	Selettiva Selective	Kg 3,9	DTS	377 mm	Gomma pieno Full rubber	Valigetta ABSPRO ABSPRO case	Bianco sferico White spherical	<i>maxis</i> CHOKE COMPETITION
INVICTUS I TRAP AT	12	70 mm DueCon <i>maxisBORE</i>	76/81	Conica Ventilata Tapered ventilated	Ventilata Ventilated	Fissa Fixed	Kg 3,9	DTS	377 mm	Gomma ventilato Ventilated rubber	Valigetta ABSPRO ABSPRO case	Bianco sferico White spherical	<i>maxis</i> CHOKE COMPETITION
INVICTUS I BLACK MSPEC SPORTING	12	70 mm DueCon <i>maxisBORE</i>	76/81	Conica Ventilata Tapered ventilated	Ventilata Ventilated	Selettiva Selective	Kg 3,75	35/55 mm	377 mm	Gomma pieno Full rubber	Valigetta ABSPRO ABSPRO case	Bianco sferico White spherical	MEPEC CHOKEES

INVICTUS I SPORTING



INVICTUS I TRAP AT **DTS**

INVICTUS I ASCENT SPORTING **DTS**

INVICTUS I BLACK MSPEC SPORTING

* I pesi sono calcolati mediamente con canne da 76 e calci di densità standard. Nell'imballo chiavi smontaggio calcio e regolazione grilletto inclusi.

* Weights are calculated with 76 cm barrels and standard stocks. Each gun comes with wrenches to remove the stock and adjust the trigger

STEEL SHOT
STEEL SHOT



A RICHIESTA
ON REQUEST

Invictus III



MODELLO MODEL	CALIBRO GAUGE	CAMERA CHAMBER	LUNGH. CANNE BARRELS LENGTH	BINDELLA SUP. TOP RIB	BINDELLA LAT. SIDE RIB	SICURA SAFETY	PESO* WEIGHT*	PIEGA DROP	LUNGH. CALCIO STOCK LENGTH	CALCIOLO PAD	IMBALLO PACKING	MIRINO SIGHT	STROZZATURE CHOKES
INVICTUS III SPORTING	12	70 mm <i>maxis</i> BORE	71/76/81	Conica Ventilata <i>Tapered ventilated</i>	Ventilata Ventilated	Selettiva Selective	Kg 3,75	35/55 mm	377 mm	Gomma pieno Full rubber	Valigetta ABSPRO ABSPRO case	Bianco sferico White spherical	<i>maxis</i> CHOKE COMPETITION
INVICTUS III TRAP	12	70 mm <i>maxis</i> BORE	76/81	Conica Ventilata <i>Tapered ventilated</i>	Ventilata Ventilated	Fissa Fixed	Kg 3,75	31/41 mm	377 mm	Gomma ventilato Ventilated rubber	Valigetta ABSPRO ABSPRO case	Bianco sferico White spherical	<i>maxis</i> CHOKE COMPETITION
INVICTUS III IMPACT SPORTING	12	70 mm <i>maxis</i> BORE	76/81	Conica Ventilata <i>Tapered ventilated</i>	Ventilata Ventilated	Selettiva Selective	Kg 3,9		377 mm	Gomma pieno Full rubber	Valigetta ABSPRO ABSPRO case	Bianco sferico White spherical	<i>maxis</i> CHOKE COMPETITION
INVICTUS III IMPACT TRAP	12	70 mm <i>maxis</i> BORE	76/81	Conica Ventilata <i>Tapered ventilated</i>	Ventilata Ventilated	Fissa Fixed	Kg 3,9		377 mm	Gomma pieno Full rubber	Valigetta ABSPRO ABSPRO case	Bianco sferico White spherical	<i>maxis</i> CHOKE COMPETITION
INVICTUS III ASCENT TRAP	12	70 mm <i>maxis</i> BORE	76/81	Conica Ventilata <i>Tapered ventilated</i>	Ventilata Ventilated	Fissa Fixed	Kg 3,9		377 mm	Gomma pieno Full rubber	Valigetta ABSPRO ABSPRO case	Bianco sferico White spherical	<i>maxis</i> CHOKE COMPETITION
INVICTUS III ASCENT SPORTING	12	70 mm <i>maxis</i> BORE	76/81	Conica Ventilata <i>Tapered ventilated</i>	Ventilata Ventilated	Selettiva Selective	Kg 3,9		377 mm	Gomma pieno Full rubber	Valigetta ABSPRO ABSPRO case	Bianco sferico White spherical	<i>maxis</i> CHOKE COMPETITION
INVICTUS III TRAP AT	12	70 mm <i>maxis</i> BORE	76/81	Conica Ventilata <i>Tapered ventilated</i>	Ventilata Ventilated	Fissa Fixed	Kg 3,9		377 mm	Gomma ventilato Ventilated rubber	Valigetta ABSPRO ABSPRO case	Bianco sferico White spherical	<i>maxis</i> CHOKE COMPETITION

* I pesi sono calcolati mediamente con canne da 76 e calci di densità standard. Nell'imballo chiavi smontaggio calcio e regolazione grilletto inclusi.

* Weights are calculated with 76 cm barrels and standard stocks. Each gun comes with wrenches to remove the stock and adjust the trigger

STEEL SHOT
STEEL SHOT



A RICHIESTA
ON REQUEST

INVICTUS III SPORTING



Invictus V



INVICTUS V SPORTING

MODELLO MODEL	CALIBRO GAUGE	CAMERA CHAMBER	LUNGH. CANNE BARRELS LENGTH	BINDELLA SUP. TOP RIB	BINDELLA LAT. SIDE RIB	SICURA SAFETY	PESO* WEIGHT*	PIEGA DROP	LUNGH. CALCIO STOCK LENGTH	CALCIOLO PAD	IMBALLO PACKING	MIRINO SIGHT	STROZZATURE CHOKES
INVICTUS V SPORTING	12	70 mm maxis BORE	71/76/81	Conica Ventilata Tapered ventilated	Ventilata Ventilated	Selettiva Selective	Kg 3,8	35/55 mm	377 mm	Gomma pieno Full rubber	Valigetta ABSPRO ABSPRO case	Bianco sferico White spherical	maxis CHOKE COMPETITION
INVICTUS V TRAP	12	70 mm maxis BORE	76/81	Conica Ventilata Tapered ventilated	Ventilata Ventilated	Fissa Fixed	Kg 3,8	31/41 mm	377 mm	Gomma ventilato Ventilated rubber	Valigetta ABSPRO ABSPRO case	Bianco sferico White spherical	maxis CHOKE COMPETITION
INVICTUS V IMPACT SPORTING	12	70 mm maxis BORE	76/81	Conica Ventilata Tapered ventilated	Ventilata Ventilated	Selettiva Selective	Kg 3,9		377 mm	Gomma pieno Full rubber	Valigetta ABSPRO ABSPRO case	Bianco sferico White spherical	maxis CHOKE COMPETITION
INVICTUS V IMPACT TRAP	12	70 mm maxis BORE	76/81	Conica Ventilata Tapered ventilated	Ventilata Ventilated	Fissa Fixed	Kg 3,9		377 mm	Gomma pieno Full rubber	Valigetta ABSPRO ABSPRO case	Bianco sferico White spherical	maxis CHOKE COMPETITION
INVICTUS V ASCENT TRAP	12	70 mm maxis BORE	76/81	Conica Ventilata Tapered ventilated	Ventilata Ventilated	Fissa Fixed	Kg 3,9		377 mm	Gomma pieno Full rubber	Valigetta ABSPRO ABSPRO case	Bianco sferico White spherical	maxis CHOKE COMPETITION
INVICTUS V ASCENT SPORTING	12	70 mm maxis BORE	76/81	Conica Ventilata Tapered ventilated	Ventilata Ventilated	Selettiva Selective	Kg 3,9		377 mm	Gomma pieno Full rubber	Valigetta ABSPRO ABSPRO case	Bianco sferico White spherical	maxis CHOKE COMPETITION
INVICTUS V TRAP AT	12	70 mm maxis BORE	76/81	Conica Ventilata Tapered ventilated	Ventilata Ventilated	Fissa Fixed	Kg 3,9		377 mm	Gomma ventilato Ventilated rubber	Valigetta ABSPRO ABSPRO case	Bianco sferico White spherical	maxis CHOKE COMPETITION
INVICTUS V MSPEC SPORTING	12	70 mm maxis BORE	76/81	Conica Ventilata Tapered ventilated	Ventilata Ventilated	Selettiva Selective	Kg 3,8	35/55 mm	377 mm	Gomma pieno Full rubber	Valigetta ABSPRO ABSPRO case	Bianco sferico White spherical	MSPEC CHOKES

* I pesi sono calcolati mediamente con canne da 76 e calci di densità standard. Nell'imballo chiavi smontaggio calcio e regolazione grilletto inclusi.

* Weights are calculated with 76 cm barrels and standard stocks. Each gun comes with wrenches to remove the stock and adjust the trigger

STEEL SHOT
STEEL SHOT



A RICHIESTA
ON REQUEST



INVICTUS V GOLD SPORTING



INVICTUS V TRAP AT



INVICTUS V ASCENT SPORTING



INVICTUS V IMPACT TRAP

Invictus VII



INVICTUS VII SPORTING

MODELLO MODEL	CALIBRO GAUGE	CAMERA CHAMBER	LUNGH. CANNE BARRELS LENGTH	BINDELLA SUP. TOP RIB	BINDELLA LAT. SIDE RIB	SICURA SAFETY	PESO* WEIGHT*	PIEGA DROP	LUNGH. CALCIO STOCK LENGTH	CALCIOLO PAD	IMBALLO PACKING	MIRINO SIGHT	STROZZATURE CHOKES
INVICTUS VII SPORTING	12	70 mm DueCon <i>maxisBORE</i>	71/76/81	Conica Ventilata <i>Tapered ventilated</i>	Ventilata Ventilated	Selettiva Selective	Kg 3,8	35/55 mm	377 mm	Gomma pieno Full rubber	Valigetta ABSPRO <i>ABSPRO case</i>	Bianco sferico <i>White spherical</i>	<i>maxis</i> CHOKE COMPETITION
INVICTUS VII TRAP	12	70 mm DueCon <i>maxisBORE</i>	76/81	Conica Ventilata <i>Tapered ventilated</i>	Ventilata Ventilated	Fissa Fixed	Kg 3,8	31/41 mm	377 mm	Gomma ventilato <i>Ventilated rubber</i>	Valigetta ABSPRO <i>ABSPRO case</i>	Bianco sferico <i>White spherical</i>	<i>maxis</i> CHOKE COMPETITION
INVICTUS VII IMPACT SPORTING	12	70 mm DueCon <i>maxisBORE</i>	76/81	Conica Ventilata <i>Tapered ventilated</i>	Ventilata Ventilated	Selettiva Selective	Kg 3,9	DTS	377 mm	Gomma pieno Full rubber	Valigetta ABSPRO <i>ABSPRO case</i>	Bianco sferico <i>White spherical</i>	<i>maxis</i> CHOKE COMPETITION
INVICTUS VII IMPACT TRAP	12	70 mm DueCon <i>maxisBORE</i>	76/81	Conica Ventilata <i>Tapered ventilated</i>	Ventilata Ventilated	Fissa Fixed	Kg 3,9	DTS	377 mm	Gomma pieno Full rubber	Valigetta ABSPRO <i>ABSPRO case</i>	Bianco sferico <i>White spherical</i>	<i>maxis</i> CHOKE COMPETITION
INVICTUS VII ASCENT TRAP	12	70 mm DueCon <i>maxisBORE</i>	76/81	Conica Ventilata <i>Tapered ventilated</i>	Ventilata Ventilated	Fissa Fixed	Kg 3,9	DTS	377 mm	Gomma pieno Full rubber	Valigetta ABSPRO <i>ABSPRO case</i>	Bianco sferico <i>White spherical</i>	<i>maxis</i> CHOKE COMPETITION
INVICTUS VII ASCENT SPORTING	12	70 mm DueCon <i>maxisBORE</i>	76/81	Conica Ventilata <i>Tapered ventilated</i>	Ventilata Ventilated	Selettiva Selective	Kg 3,9	DTS	377 mm	Gomma pieno Full rubber	Valigetta ABSPRO <i>ABSPRO case</i>	Bianco sferico <i>White spherical</i>	<i>maxis</i> CHOKE COMPETITION
INVICTUS VII TRAP AT	12	70 mm DueCon <i>maxisBORE</i>	76/81	Conica Ventilata <i>Tapered ventilated</i>	Ventilata Ventilated	Fissa Fixed	Kg 3,9	DTS	377 mm	Gomma ventilato <i>Ventilated rubber</i>	Valigetta ABSPRO <i>ABSPRO case</i>	Bianco sferico <i>White spherical</i>	<i>maxis</i> CHOKE COMPETITION

* I pesi sono calcolati mediamente con canne da 76 e calci di densità standard. Nell'imballo chiavi smontaggio calcio e regolazione grilletto inclusi.

* Weights are calculated with 76 cm barrels and standard stocks. Each gun comes with wrenches to remove the stock and adjust the trigger

STEEL SHOT
STEEL SHOT



A RICHIESTA
ON REQUEST



INVICTUS VII GOLD



INVICTUS VII TRAP AT **DTS**



INVICTUS VII ASCENT SPORTING **DTS**



INVICTUS VII IMPACT SPORTING **DTS**

Figura - Figura Light



MODELLO MODEL	CALIBRO GAUGE	CAMERA CHAMBER	LUNGH. CANNE BARRELS LENGTH	BINDELLA SUP. TOP RIB	BINDELLA LAT. SIDE RIB	PESO* WEIGHT*	PIEGA DROP	LUNGH. CALCIO STOCK LENGTH	CALCIOLO PAD	IMBALLO PACKING	MIRINO SIGHT	STROZZATURE CHOKES
FIGURA	12	76 mm DueCon <i>maxis</i> BORE	61/66/71/76	Conica <i>Tapered</i>	Intera <i>Full</i>	Kg 3,05	37/57 mm	375 mm	Plastica zigrinato Plastic checkered	Valigetta Injec Injec case	Ottone Brass	5 <i>maxis</i> CHOKE
FIGURA LIGHT	12	76 mm DueCon <i>maxis</i> BORE	61/66/71/76	Conica <i>Tapered</i>	Intera <i>Full</i>	Kg 2,7	37/57 mm	375 mm	Plastica zigrinato Plastic checkered	Valigetta Injec Injec case	Ottone Brass	5 <i>maxis</i> CHOKE

* I pesi sono calcolati mediamente con canne da cm 71 e calci di densità standard. Nell'imballo portacinghia incluso.

* Weights are calculated with 71 cm barrels and standard stocks. Available in the box sling swivel.



FIGURA



FIGURA LIGHT



Tempio - Tempio Light



MODELLO MODEL	CALIBRO GAUGE	CAMERA CHAMBER	LUNGH. CANNE* BARRELS LENGTH*	BINDELLA SUP. TOP RIB	BINDELLA LAT. SIDE RIB	PESO** WEIGHT**	PIEGA DROP	LUNGH. CALCIO STOCK LENGTH	CALCIOLO PAD	IMBALLO PACKING	MIRINO SIGHT	STROZZATURE CHOKES
TEMPIO	12	76 mm <i>maxis</i> BORE	61/66/71/76	Conica Tapered	Intera Full	Kg 3,1	37/57 mm	375 mm	Legno zigrinato Wood checkered	Valigetta Injec Injec case	Ottone Brass	5 <i>maxis</i> CHOKE
	20/36	76 mm		6 mm		Kg 2,85						5 Selectachoke
	28	70 mm***										
TEMPIO COMPACT	12	76 mm <i>maxis</i> BORE	61/66/71/76	Conica Tapered	Intera Full	Kg 3,1	36/45/64 mm	356 mm	Legno zigrinato Wood checkered	Valigetta Injec Injec case	Ottone Brass	5 <i>maxis</i> CHOKE
	20/36	76 mm		6 mm		Kg 2,85						5 Selectachoke
	28	70 mm***										
TEMPIO LIGHT	12	76 mm <i>maxis</i> BORE	61/66/71/76	Conica Tapered	Intera Full	Kg 2,7	37/57 mm	375 mm	Legno zigrinato Wood checkered	Valigetta Injec Injec case	Ottone Brass	5 <i>maxis</i> CHOKE
	20/36	76 mm		6 mm		Kg 2,5						5 Selectachoke
	28	70 mm***										
TEMPIO LIGHT COMPACT	12	76 mm <i>maxis</i> BORE	61/66/71/76	Conica Tapered	Intera Full	Kg 2,7	36/45/64 mm	356 mm	Legno zigrinato Wood checkered	Valigetta Injec Injec case	Ottone Brass	5 <i>maxis</i> CHOKE
	20/36	76 mm		6 mm		Kg 2,5						5 Selectachoke
	28	70 mm***										

TEMPIO



TEMPIO LIGHT



TEMPIO COMPACT



* Canne da cm 61 disponibili solo per i calibri 12 / 20.
* Canne da cm 76 disponibili solo per i calibri 12 / 20 / 28.
** I pesi sono calcolati mediamente con canne da 71 cm e calci di densità standard. Nell'imballo portacinghia incluso.
*** Camera da 70 mm disponibile solo in cal. 28.

* 61 cm barrels available on 12 / 20 ga. only.
* 76 cm barrels available on 12 / 20 / 28 ga. only.
** Weights are calculated with 71 cm barrels and standard stocks.
Available in the box sling swivel.
*** 70 mm chamber on 28 ga. only.





Magnus Limited - Magnus Light



MODELLO MODEL	CALIBRO GAUGE	CAMERA CHAMBER	LUNGH. CANNE* BARRELS LENGHT*	BINDELLA SUP. TOP RIB	BINDELLA LAT. SIDE RIB	PESO** WEIGHT**	PIEGA DROP	LUNGH. CALCIO STOCK LENGTH	CALCIOLO PAD	IMBALLO PACKING	MIRINO SIGHT	STROZZATURE CHOKES
MAGNUS LIMITED	12	76 mm maxisBORE	61/66/71/76	Conica <i>Tapered</i>	Intera <i>Full</i>	Kg 3,15	37/57 mm	375 mm	Legno zigrinato <i>Wood checkered</i>	Valigetta Injec <i>Injec case</i>	Ottone <i>Brass</i>	5 maxis CHOKE
	20/36	76 mm		6 mm		Kg 2,9						5 Selectachoke
	28	70 mm***										
MAGNUS LIGHT	12	76 mm maxisBORE	61/66/71/76	Conica <i>Tapered</i>	Intera <i>Full</i>	Kg 2,7	37/57 mm	375 mm	Legno zigrinato <i>Wood checkered</i>	Valigetta Injec <i>Injec case</i>	Ottone <i>Brass</i>	5 maxis CHOKE
	20/36	76 mm		6 mm		Kg 2,5						5 Selectachoke
	28	70 mm***										

MAGNUS LIMITED



MAGNUS LIGHT

* Canne da cm 61 disponibili solo per i calibri 12 / 20.
 * Canne da cm 76 disponibili solo per i calibri 12 / 20 / 28.
 ** I pesi sono calcolati mediamente con canne da 71 cm e calci di densità standard. Nell'imballo portacinghia incluso.
 *** Camera da 70 mm disponibile solo in cal. 28.

* 61 cm barrels available on 12 / 20 ga. only.
 * 76 cm barrels available on 12 / 20 / 28 ga. only.
 ** Weights are calculated with 71 cm barrels and standard stocks.
 Available in the box sling swivel.
 *** 70 mm chamber on 28 ga. only.

STEEL SHOT PROOF TESTED
 STEEL SHOT NEI cal. 12 e 20
 12 AND 20 ga.



Maxum



MODELLO MODEL	CALIBRO GAUGE	CAMERA CHAMBER	LUNGH. CANNE* BARRELS LENGTH*	BINDELLA SUP. TOP RIB	BINDELLA LAT. SIDE RIB	PESO** WEIGHT**	PIEGA DROP	LUNGH. CALCIO STOCK LENGTH	CALCIOLO PAD	IMBALLO PACKING	MIRINO SIGHT	STROZZATURE CHOKES
MAXUM	12	76 mm DueCon <i>maxisBORE</i>	66/71/76	Conica <i>Tapered</i>	Intera <i>Full</i>	Kg 3,15	37/57 mm	375 mm	Legno zigrinato <i>Wood checkered</i>	Valigetta Thermo <i>Thermo case</i>	Ottone <i>Brass</i>	5 <i>maxis</i> CHOKE
	20/36	76 mm				Kg 2,9						5 Selectachoke
	28	70 mm***										

* Canne da cm 76 disponibili solo per i calibri 12 / 20 / 28.
 ** I pesi sono calcolati mediamente con canne da 71 cm e calci di densità standard. Nell'imballo portacinghia incluso.
 *** Camera da 70 mm disponibile solo in cal. 28.

* 76 cm barrels available on 12 / 20 / 28 ga. only.
 ** Weights are calculated with 71 cm barrels and standard stocks.
 Available in the box sling swivel.
 *** 70 mm chamber on 28 ga. only.

STEEL SHOT
STEEL SHOT



NEI cal. 12 e 20
12 AND 20 ga.



MAXUM



Apex



MODELLO MODEL	CALIBRO GAUGE	CAMERA CHAMBER	LUNGH. CANNE* BARRELS LENGTH*	BINDELLA SUP. TOP RIB	BINDELLA LAT. SIDE RIB	PESO** WEIGHT**	PIEGA DROP	LUNGH. CALCIO STOCK LENGTH	CALCIOLO PAD	IMBALLO PACKING	MIRINO SIGHT	STROZZATURE CHOKES
APEX	12	76 mm DueCon <i>maxis</i> BORE	66/71/76	Conica <i>Tapered</i>	Intera <i>Full</i>	Kg 3,2	37/57 mm	375 mm	Legno zigrinato <i>Wood checkered</i>	Valigetta Thermo inserti in pelle <i>Thermo leather accent case</i>	Ottone <i>Brass</i>	5 <i>maxis</i> CHOKE
	20/36	76 mm				Kg 2,95						5 Selectachoke
	28	70 mm***										

* Canne da cm 76 disponibili solo per i calibri 12 / 20 / 28.
 ** I pesi sono calcolati mediamente con canne da 71 cm e calci di densità standard. Nell'imballo portacinghia incluso.
 *** Camera da 70 mm disponibile solo in cal. 28.
 * 76 cm barrels available on 12 / 20 / 28 ga. only.
 ** Weights are calculated with 71 cm barrels and standard stocks.
 Available in the box sling swivel.
 *** 70 mm chamber on 28 ga. only.



APEX



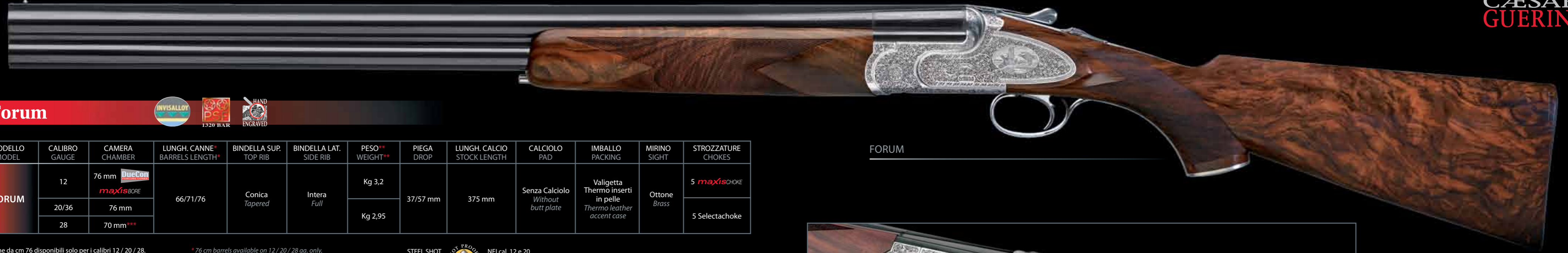

Forum



MODELLO MODEL	CALIBRO GAUGE	CAMERA CHAMBER	LUNGH. CANNE* BARRELS LENGTH*	BINDELLA SUP. TOP RIB	BINDELLA LAT. SIDE RIB	PESO** WEIGHT**	PIEGA DROP	LUNGH. CALCIO STOCK LENGTH	CALCIOLO PAD	IMBALLO PACKING	MIRINO SIGHT	STROZZATURE CHOKES
FORUM	12	76 mm DueCon <i>maxis</i> BORE	66/71/76	Conica <i>Tapered</i>	Intera <i>Full</i>	Kg 3,2	37/57 mm	375 mm	Senza Calciolo <i>Without butt plate</i>	Valigetta Thermo inserti in pelle <i>Thermo leather accent case</i>	Ottone <i>Brass</i>	5 <i>maxis</i> CHOKE
	20/36	76 mm				Kg 2,95						5 Selectachoke
	28	70 mm***										

FORUM

* Canne da cm 76 disponibili solo per i calibri 12 / 20 / 28.
** I pesi sono calcolati mediamente con canne da 71 cm e calci di densità standard. Nell'imballo portacinghia incluso.
*** Camera da 70 mm disponibile solo in cal. 28.

* 76 cm barrels available on 12 / 20 / 28 ga. only.
** Weights are calculated with 71 cm barrels and standard stocks.
Available in the box sling swivel.
*** 70 mm chamber on 28 ga. only.





Ellipse Curve - Ellipse Evo - Ellipse Evo Light



MODELLO MODEL	CALIBRO GAUGE	CAMERA CHAMBER	LUNGH. CANNE* BARRELS LENGTH*	BINDELLA SUP. TOP RIB	BINDELLA LAT. SIDE RIB	PESO** WEIGHT**	PIEGA DROP	LUNGH. CALCIO STOCK LENGTH	CALCIOLO PAD	IMBALLO PACKING	MIRINO SIGHT	STROZZATURE CHOKES
ELLIPSE CURVE GOLD	12	76 mm maxisBORE	66/71/76	Conica Tapered	Intera Full	Kg 3,1	37/57 mm	375 mm	Legno zigrinato Wood checkered	Valigetta Thermo Thermo Case	Ottone Brass	5 maxis CHOKE
	20/36	76 mm				Kg 2,9						5 Selectachoke
	28	70 mm***										
ELLIPSE CURVE	12	76 mm maxisBORE	66/71/76	Conica Tapered	Intera Full	Kg 3,1	37/57 mm	375 mm	Legno zigrinato Wood checkered	Valigetta Thermo Thermo Case	Ottone Brass	5 maxis CHOKE
	20/36	76 mm				Kg 2,9						5 Selectachoke
	28	70 mm***										
ELLIPSE EVO	12	76 mm maxisBORE	66/71/76	Conica Tapered	Intera Full	Kg 3,1	37/57 mm	375 mm	Legno zigrinato Wood checkered	Valigetta Thermo Thermo Case	Ottone Brass	5 maxis CHOKE
	20/36	76 mm				Kg 2,9						5 Selectachoke
	28	70 mm***										
ELLIPSE EVO LIGHT	12	76 mm maxisBORE	66/71/76	Conica Tapered	Intera Full	Kg 2,7	37/57 mm	375 mm	Legno zigrinato Wood checkered	Valigetta Thermo Thermo Case	Ottone Brass	5 maxis CHOKE
	20/36	76 mm				Kg 2,5						5 Selectachoke
	28	70 mm***										



ELLIPSE CURVE



ELLIPSE CURVE GOLD



ELLIPSE EVO LIGHT



* Canne da cm 76 disponibili solo per i calibri 12 / 20 / 28.
** I pesi sono calcolati mediamente con canne da 71 cm e calci di densità standard. Nell'imballo portacinghia incluso.
*** Camera da 70 mm disponibile solo in cal. 28.

* 76 cm barrels available on 12 / 20 / 28 ga. only.
** Weights are calculated with 71 cm barrels and standard stocks. Available in the box sling swivel.
*** 70 mm chamber on 28 ga. only.



NEI cal. 12 e 20
12 AND 20 ga.



Revenant



MODELLO MODEL	CALIBRO GAUGE	CAMERA CHAMBER	LUNGH. CANNE* BARRELS LENGTH*	BINDELLA SUP. TOP RIB	BINDELLA LAT. SIDE RIB	PESO** WEIGHT**	PIEGA DROP	LUNGH. CALCIO STOCK LENGTH	CALCIOLO PAD	IMBALLO PACKING	MIRINO SIGHT	STROZZATURE CHOKES
REVENANT	20	76 mm	66/71/76	Conica <i>Tapered</i>	Intera <i>Full</i>	Kg 2,95	37/57 mm	375 mm	Legno zigrinato <i>Wood checkered</i>	Valigetta Thermo Wooden <i>Thermo Wooden case</i>	Ottone <i>Brass</i>	5 Selectachoke

REVENANT

** I pesi sono calcolati mediamente con canne da 71 cm e calci di densità standard. Nell'imballo portacinghia incluso.

** Weights are calculated with 71 cm barrels and standard stocks. Available in the box sling swivel.

STEEL SHOT
STEEL SHOT





**Express Trofeo - Express Reflexo - Express Maxum
Express Ellipse Evo - Express Ellipse Evo Light**



MODELLO MODEL	CALIBRO GAUGE	LUNGH. CANNE BARRELS LENGTH	BINDELLA SUP. TOP RIB	BINDELLA LAT. SIDE RIB	PESO WEIGHT	LUNGH. CALCIO STOCK LENGTH	CALCIOLO PAD	IMBALLO PACKING	MIRINO SIGHT
EXPRESS TROFEO EXPRESS REFLEXO EXPRESS MAXUM EXPRESS ELLIPSE EVO	8x57 JRS	55	Conica con predisposizioni per ottiche <i>Tapered suitable for scopes</i>	Intera <i>Full</i>	Kg 3,150	375 mm	Legno zigrinato <i>Wood checkered</i>	Valigetta Thermo <i>Thermo case</i>	Tacca di mira e mirino in fibra ottica fluorescente <i>Rear sight and fluorescent sight in optic fiber</i>
	30 R Blaser								
	9,3x74R								
EXPRESS ELLIPSE EVO LIGHT	8x57 JRS	55	Conica con predisposizioni per ottiche <i>Tapered suitable for scopes</i>	Intera <i>Full</i>	Kg 2,950	375 mm	Legno zigrinato <i>Wood checkered</i>	Valigetta Thermo <i>Thermo case</i>	Tacca di mira e mirino in fibra ottica fluorescente <i>Rear sight and fluorescent sight in optic fiber</i>

EXPRESS TROFEO



EXPRESS MAXUM



EXPRESS ELLIPSE EVO



EXPRESS ELLIPSE EVO LIGHT



EXPRESS REFLEXO

Caratteristiche tecniche dei fucili semiautomatici

Semiautomatic shotguns technical features

I fucili semiautomatici, al contrario di quanto si potrebbe pensare, sono più facili da costruire dei sovraposti. Tuttavia devono avere caratteristiche tali da consentirne un uso facile, sicuro e privo di problemi meccanici che ne possano pregiudicare la durata nel tempo. Le doti fondamentali devono essere un buon assorbimento del rinculo, la possibilità di esplodere qualsiasi tipo di munizione, da quelle più leggere alle magnum e una resa balistica sempre ottimale.

La Caesar Guerini ha fatto di queste caratteristiche la propria filosofia e propone una completa gamma di semiautomatici a funzionamento inerziale in grado di soddisfare tutte le esigenze del cacciatore sia in fatto di estetica che di necessità, con modelli adatti a ogni tipo di caccia.

Il cuore del funzionamento dei semiautomatici inerziali della Caesar Guerini è composto da una speciale doppia molla a disco (non elicoidale) posta sul tubo del serbatoio nella zona anteriore dell'asta.

In caso di rottura di una delle sue parti il fucile è comunque in grado di funzionare. L'aver adottato una molla più "nobile" e quindi più elastica e omogenea nel lavoro, permette di generare un rinculo minore.

Contrary to popular thought, semiautomatic shotguns are easier to build than Over and Under shotguns but they have to be easy to operate, safe to use and completely free from mechanical issues that could compromise their longevity.

A good semiautomatic shotgun has to absorb recoil, fire any type of ammunition from the lightest loads and still maintain excellent ballistic performance.

Caesar Guerini has incorporated these important features into its production philosophy and offers a complete line of inertia-operated semiautomatic shotguns that meet hunter's requests and needs.



Inertia-operated semiautomatic shotguns offered by Caesar Guerini work with a special double disk spring (not a coil spring) located on the magazine in the front fore-end section. Should one of the components break, the shotgun would still operate. Using a better, more elastic and smooth spring generates less recoil.

La massa cinetica di compressione della molla inerziale, essendo posta nella zona anteriore del fucile anziché in quella posteriore, consente una maggiore stabilità della canna durante lo sparo, offrendo una sensazione di maggiore confort e riducendo notevolmente il rilevamento della canna.

The kinetic mass that compresses the inertia spring is situated in the front part of the shotgun instead of the rear which makes the barrels more stable, offering a more comfortable sensation and reduces felt recoil while shooting.

Il carrello di armamento è costituito da un corpo monolitico con due aste parallele simmetriche che conferiscono notevole stabilità sul piano orizzontale.

The cocking slide is a monolithic body with two parallel symmetrical bars that enhance the shotgun stability.

La molla di recupero, posizionata sul tubo del serbatoio, lavora in maniera assiale e parallela all'asse della canna ed è di facile smontaggio e pulizia.

Questo costituisce una novità rispetto ad altri semiautomatici inerziali che collocano la molla di recupero all'interno del calcio.

The recoil spring situated on the magazine works parallel to the barrel axis and is extremely easy to remove and clean.

This is a unique feature for Caesar Guerini when compared with other inertia semiautomatic shotguns where the recoil spring is situated inside the stock.

Gli ammortizzatori del fucile sono posti in diversi punti: quello più rilevante è situato dietro l'otturatore e ha una base di lavoro estremamente ampia che gli permette di assorbire molto bene anche i rinculi più esasperati.

L'espulsore è mobile e quindi consente di trovare l'ottimale posizione per l'espulsione



di qualsiasi tipo di munizione.

La sostituzione della cartuccia in camera è agevolata da un particolare sistema di elevatore libero che consente un rapido avvicendamento delle munizioni, azionando semplicemente la manetta dell'otturatore.

Un pratico pulsante consente la chiusura dell'otturatore.

Il rampone di chiusura oscillante consente di avere una carcassa più corta e compatta con le stesse garanzie di sicurezza offerte da altre chiusure.

There are several shock absorbers in the gun: the most important one is situated behind the locking bolt and is wide enough to absorb even the strongest recoil.

The ejector moves and can be put in the best



possible position to eject any ammunition. Chambering cartridges is easy thanks to a special free floating carrier that makes it possible to rapidly cycle ammunition just operating the bolt handle. A convenient button closes the locking bolt. The oscillating locking lug makes it possible to have a shorter and more compact receiver without compromising the safety.

Sotto ponendo preventivamente il fucile alla prova Steel Shot, l'arma, abbinata agli speciali strozzatori può esplodere munizioni con pallini di acciaio.

La calciatura è molto elegante e viene dotata di una pistola arrotondata tipo "Principe di Galles". Questa pistola, realizzata a mano, si differenzia dalle comuni pistole tonde eseguite a macchina e impiegate nei fucili economici, conferendo inoltre una forte caratterizzazione al fucile.

Dal punto di vista pratico, essendo priva di angoli, permette una presa confortevole e pronta anche a mani di dimensioni diverse.

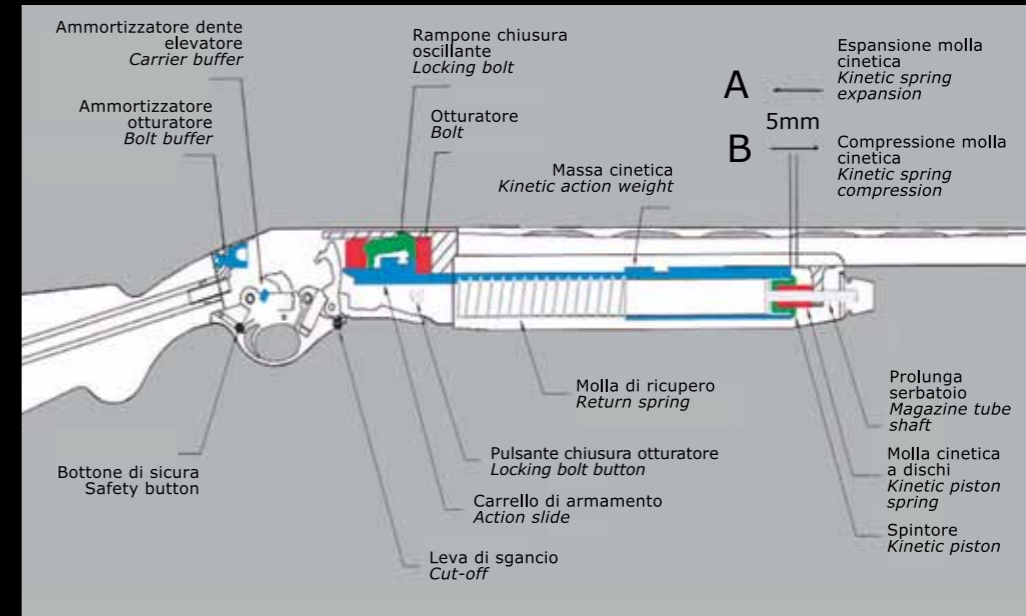

Il nuovo calciolo morbido è stato studiato per assorbire perfettamente il già limitato rinculo. Caesar Guerini semiautomatic shotguns that have passed the Steel Shot Test can fire steel shot ammunition if provided with the correct chokes.

Our semiautomatic shotguns come with very elegant, hand-cut Prince of Wales pistol grip stocks, which differ substantially from the other machine-made round pistol grips, used on inexpensive guns.

The Prince of Wales stocks also enhance the gun's personality. Devoid of corners, the grip makes the gun easy to handle for different-sized hands. The new soft pad has been specifically designed to perfectly absorb the already limited recoil.

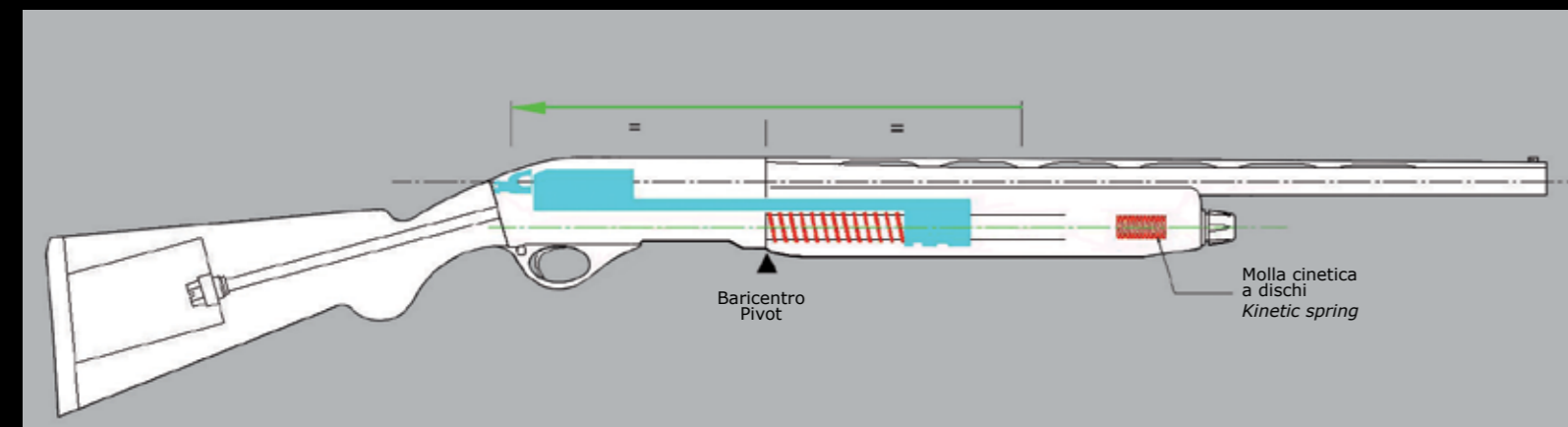

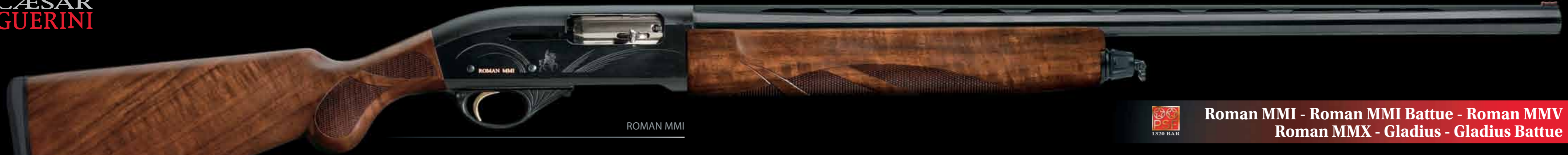

ROMAN MMI



**Roman MMI - Roman MMI Battue - Roman MMV
Roman MMX - Gladius - Gladius Battue**



ROMAN MMI BATTUE



CANNA PARADOX - PARADOX BARREL



MODELLO MODEL	CALIBRO GAUGE	CAMERA CHAMBER	LUNGH. CANNE BARRELS LENGTH	BINDELLA SUP. TOP RIB	PESO* WEIGHT*	PIEGA DROP	LUNGH. CALCIO STOCK LENGTH	CALCIOLO PAD	IMBALLO PACKING	MIRINO SIGHT	STROZZATURE CHOKES
ROMAN MMI	12	76 mm	61/66/71/76	6 mm	Kg 3,05	36/57 mm	368 mm	Gomma pieno Full rubber	Valigetta Injec Injec case	Fibra ottica rosso Red optic fiber	5 <i>maxis</i> CHOKE
ROMAN MMI BATTUE		76 mm	BATTUE 61		Kg 2,95						RAYE
ROMAN MMV	12	76 mm	61/66/71/76	6 mm	Kg 3,05	36/57 mm	368 mm	Gomma pieno Full rubber	Valigetta Injec Injec case	Fibra ottica rosso Red optic fiber	5 <i>maxis</i> CHOKE
ROMAN MMX	12	76 mm	61/66/71/76	6 mm	Kg 3,05	36/57 mm	368 mm	Gomma pieno Full rubber	Valigetta Injec Injec case	Fibra ottica rosso Red optic fiber	5 <i>maxis</i> CHOKE
GLADIUS	12	76 mm	61/66/71/76	6 mm	Kg 3,05	36/57 mm	368 mm	Gomma Pieno Full Rubber	Valigetta Injec Injec Case	Fibra Ottica Rosso Red Optic Fiber	5 <i>maxis</i> CHOKE
GLADIUS BATTUE		76 mm	BATTUE 61		Kg 2,95						RAYE



STEEL SHOT
STEEL SHOT



* I pesi sono calcolati mediamente con canne da 71 e calci di densità standard. Nell'imballo portacinghia incluso. Disponibili canne con strozzatura fissa.

* Weights are calculated with 71 cm barrels and standard stocks. In the box sling swivel. Available barrels with fixed chokes.



ROMAN MMX



ROMAN MMX



ROMAN MMX



ROMAN MMV



GLADIUS



GLADIUS BATTUE

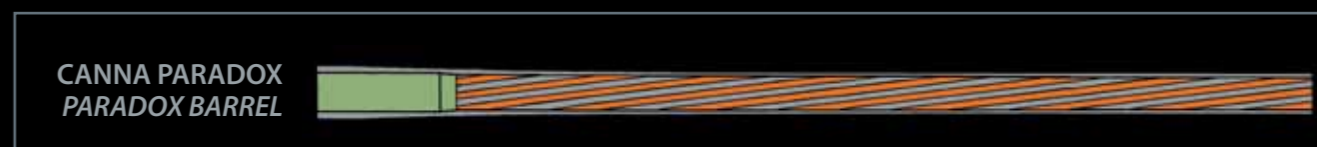

CANNA PARADOX
PARADOX BARREL

**ACCESSORI
ACCESSORIES**



MOD. INJEC
Valigetta in ABS per fucile sovrapposto e semiautomatico.
MOD. INJEC
Case in ABS for O/U and semiautomatic shotgun.



MOD. THERMO - Valigetta in ABS con serratura a combinazione per fucile sovrapposto.
MOD. THERMO - Case in ABS with combination lock for O/U shotgun.



THERMO INSERTI PELLE - Valigetta in ABS con inserti in pelle e serratura a combinazione per fucile sovrapposto.
THERMO LEATHER ACCENT - Case in ABS with leather accent and combination lock for O/U shotgun.



MOD. ABSPRO
Valigetta in ABS con serratura a combinazione per fucile sovrapposto. Disponibile anche nella versione Combo 2 per fucile sovrapposto e canna combo e nella versione Combo 3 per fucile sovrapposto e due canne combo.

MOD. ABSPRO
Case in ABS with combination lock for o/u shotgun. Available also Combo 2 model for o/u shotgun and combo barrel and Combo 3 model for o/u shotgun and two combo barrels.



MOD. ABSPRO CON INSERTI IN PELLE
Valigetta in ABS con inserti in pelle e serratura a combinazione per fucile sovrapposto. Disponibile anche nella versione Combo 2 per fucile sovrapposto e canna combo e nella versione Combo 3 per fucile sovrapposto e due canne combo.
MOD. ABSPRO WITH LEATHER ACCENT
Case in ABS with leather accent and combination lock for o/u shotgun. Available also Combo 2 model for o/u shotgun and combo barrel and Combo 3 model for o/u shotgun and two combo barrels.



THERMO PER COPPIA DI FUCILI - Valigetta in ABS con serratura a combinazione per due fucili sovrapposti.
THERMO GUN CASE FOR PAIRS
Case in ABS with combination lock for two over and under shotguns.



THERMO BORDI IN PELLE PER COPPIA DI FUCILI
Valigetta in ABS con bordi in pelle e serratura a combinazione per due fucili sovrapposti.
THERMO GUN CASE WITH LEATHER EGDES FOR PAIRS
Case in ABS with leather edges and combination lock for two over and under shotguns.



THERMO PELLE - Valigetta in pelle con serratura a combinazione per fucile sovrapposto. Disponibile anche in versione combo 2 canne.
THERMO LEATHER - Leather case with combination lock for O/U shotgun. On request available for O/U shotgun and combo barrel.



THERMO RADICA - Valigetta in ABS-radica, con inserti in pelle e serratura a combinazione per fucile sovrapposto.
THERMO WOODEN - Case in wooden-ABS, with leather accents and combination lock for O/U shotgun.



Fodero portafucile da tiro
Competition gun slip



Fodero portafucile da caccia
Field gun slip

ACCESSORI
ACCESSORIES



Gilet da tiro rosso e nero
Red & Black shooting vest



Gilet da tiro nero con pelle nera
Black shooting vest with black leather



Gilet da tiro nero con pelle scamosciata grigia
Black shooting vest with grey suede



T-Shirt bianca
White T-Shirt



Foderine in panno
Cloth sheath



Borsa porta cartucce nera
Black shell pouch



T-Shirt Nera
Black T-Shirt



Tappetino per esposizione
Counter mats



Borsa da tiro multitasche nera
Black shooter duffle bag with multiple pockets

Cappellino rosso
Red hat



Cappellino nero e bianco
Black and white hat.



Cappellino blu e grigio
Blue and grey hat



Cappellino nero
Black hat



Cappellino arancio
Orange hat



Polo manica lunga
Polo long sleeve



Salvietta
Towel



Cuffie antirumore
Ear muffs



Guanti da tiro
Gloves



Kit pulizia calcio
Wood finishing kit



DTS Kinetic Balancer per calcio
Stock's DTS Kinetic Balancer



Set DTS Balancer
per canna 60 gr.
DTS barrel Balancer
set 60 gr.



Nasello "No Impact"
"No Impact" comb

STROZZATORI - CHOKES



CACCIA - HUNTING

	*	**	***	****	
	F	IM	M	IC	CYL
maxis CHOKE cal. 12	•	•	•	•	•
SELECTACHOKE cal. 20	•	•	•	•	•
SELECTACHOKE cal. 28	•	•	•	•	•
SELECTACHOKE cal. 36	•	•	•	•	•

TIRO - COMPETITION

	F	LF	IM	M	LM	IC	S	C
maxis CHOKE COMPETITION cal.12	•	•	•	•	•	•	•	•
SELECTACHOKE COMPETITION cal. 20	•	•	•	•	•	•	•	•
SELECTACHOKE COMPETITION cal. 28	•	•	•	•	•	•	•	•
SELECTACHOKE COMPETITION cal. 36	•	•	•	•	•	•	•	•

**CAESAR
GUERINI**

Ci riserviamo il diritto di apportare in ogni momento, a nostro criterio e senza preavviso, migliorie o modifiche ai nostri prodotti. Le descrizioni, le illustrazioni ed i dati contenuti nei cataloghi non hanno carattere impegnativo.

We will reserve the right to change and improve the products at any time to our own discretion and without notice. All descriptions, pictures and data included in the catalogues are not binding

CAESAR GUERINI

CAESAR
GUERINI

CAESAR GUERINI s.r.l
Via Canossi, 18F - 25060 Marcheno (Brescia) Italy
Telefono +39 030 89 66 144 r.a. - Fax +39 030 89 66 147

caesarguerini.it • info@caesarguerini.it